

## 1 Setting up your UCX pro Wifi Module

Plug in the wifi module to any open end of a UCX pro, make sure the UCX pro unit is powered. Make sure all UCX pro lights are set in GROUP mode; To do so, turn off the lights, touch and hold the MODE button to switch to GROUP mode. Make sure the blue LED signal light on the UCX pro is indicating it is in GROUP mode.

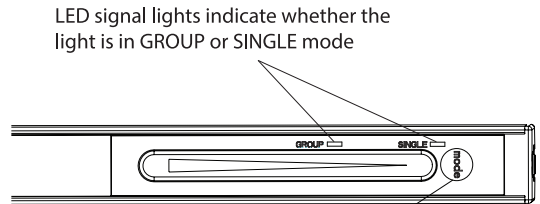
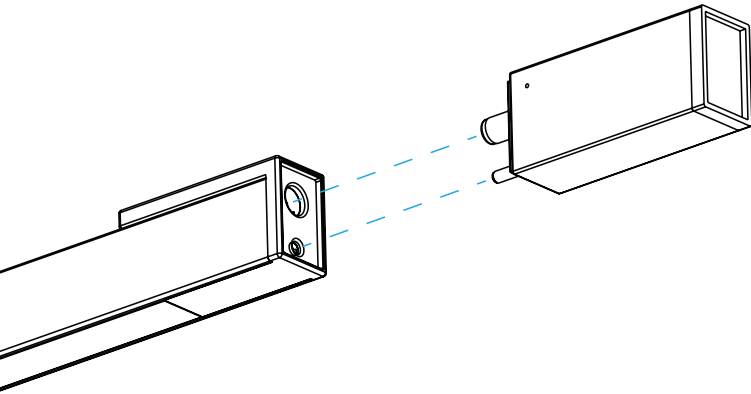

When OFF: Touch and hold the MODE button to switch between GROUP or SINGLE mode

## 2 Installing the Koncept app



Proceed to the App Store on an iPhone or the Play Store on an Android phone, search for the "Koncept wifi control" app and download to install the Koncept app.

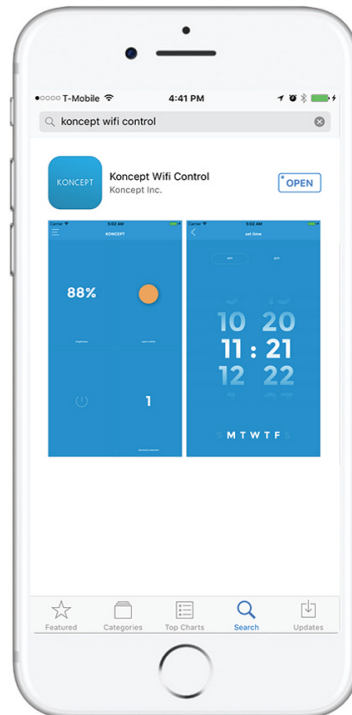
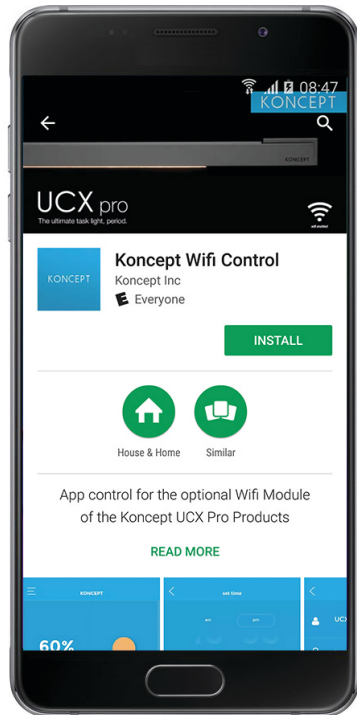

### 3 Connecting to your Wifi network

There are different methods to connect the module to your network, for iPhones and Android phones, please follow the below instructions accordingly.

#### for iPhone

You should notice a slowly blinking blue LED on the wifi module, which means it is in AP mode ready for setup.

Connect your phone to the wifi network **\_koncept\_**

A pop up window like below should show up.

Go ahead enter your network ID and password.

(note: 5G networks are not supported. network ID and password are case-sensitive)

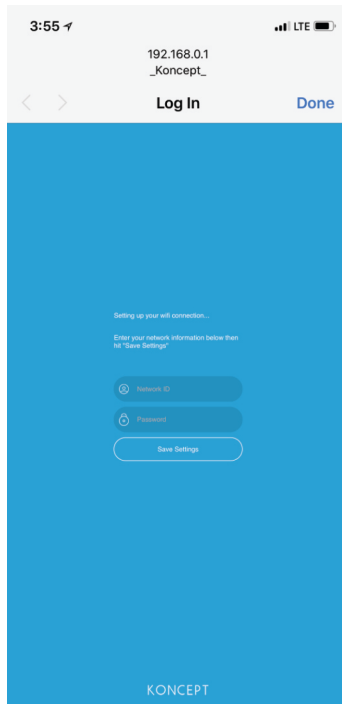
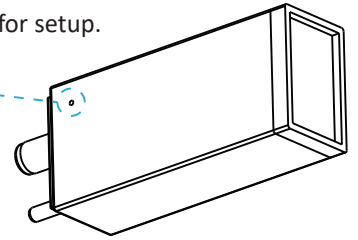

**(Alternatively)** In case the pop up window did not show up, open the Koncept app.

Click on the menu icon at the top left corner, select "+ ADD A DEVICE" on the menu.

It will now detect the device and ask you to enter your wifi Network ID and password. Go ahead enter your network ID and password.

(note: 5G networks are not supported. network ID and password are case-sensitive)

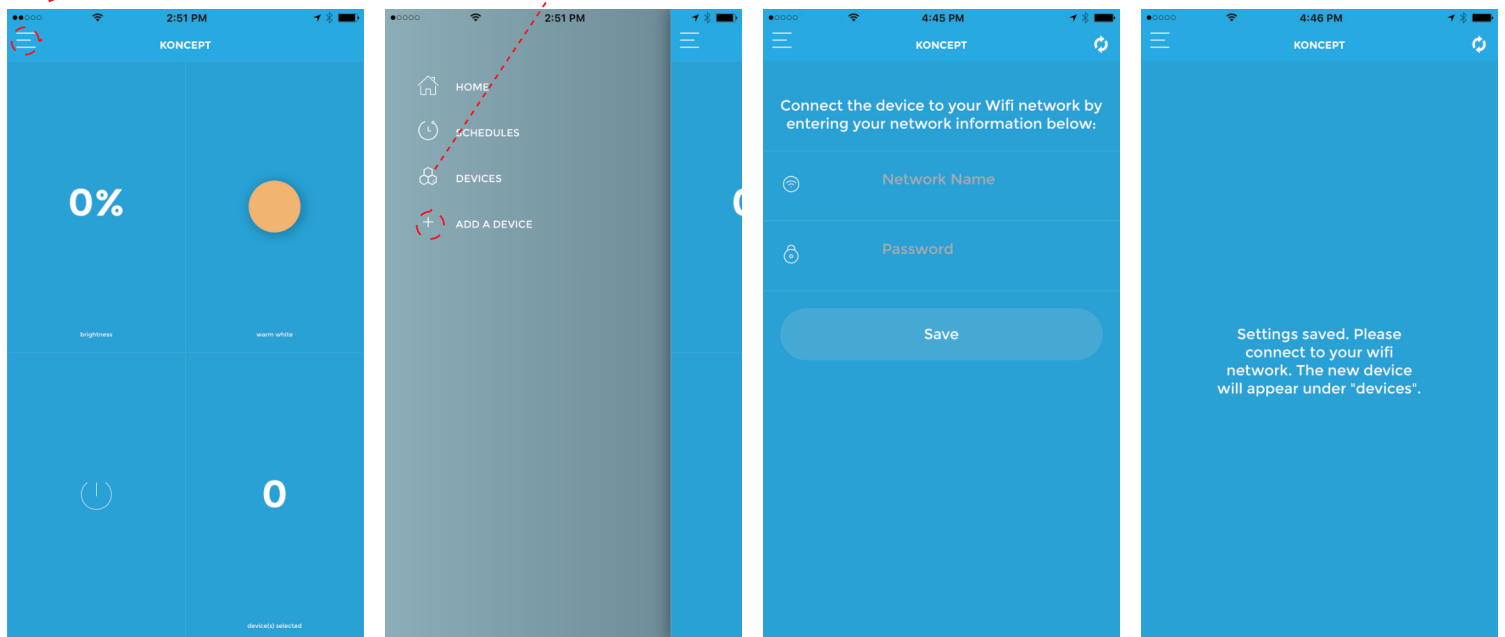

The blue LED will become solid after the Wifi module is connected to your network. Now connect your phone to back to your wifi.

for Android phone

You should notice a slowly blinking blue LED on the wifi module, which means it is in AP mode ready for setup.

Connect your phone to the wifi network **\_koncept\_**

A pop up message like below would show up, tap on that, it would then bring you to the other page.

Please enter your network ID and password.

(note: 5G networks are not supported. network ID and password are case-sensitive)

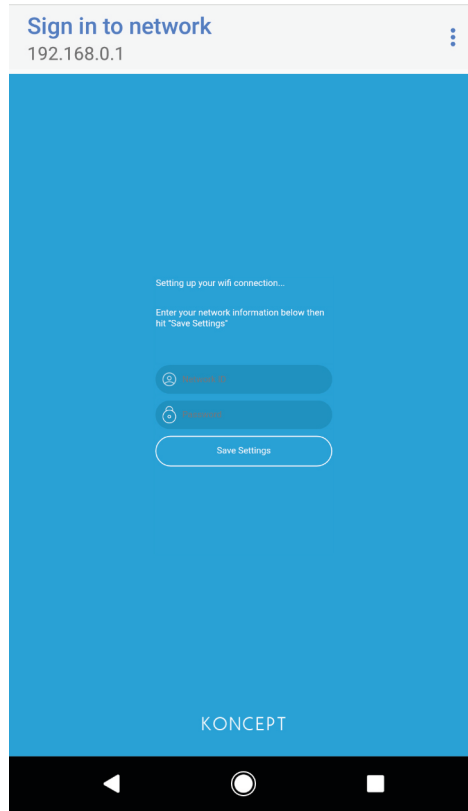
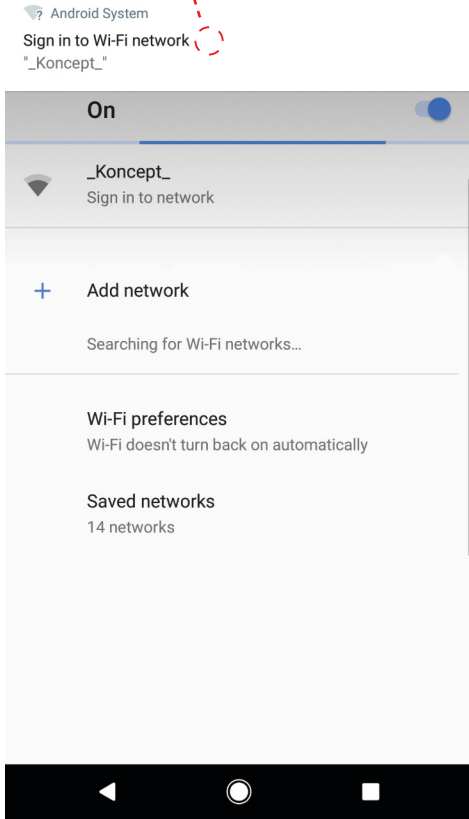
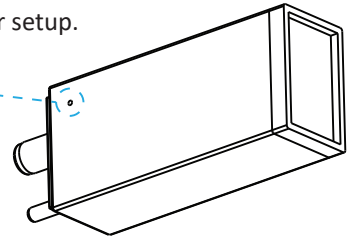

The blue LED will become solid after it is connected.

**(Alternatively)** In case the pop up window did not show up  
Wait for a popup notification from the system that says "Wi-Fi has no Internet access", tap on it, and select "yes" to stay connected.

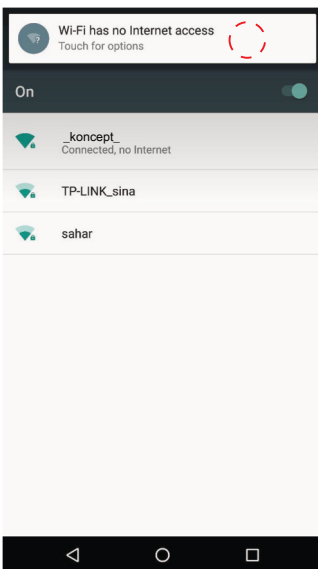

This network has no internet access. Stay connected?  
 Don't ask again for this network

No Yes

Now open Koncept App, click on the menu icon at the top left corner, select "+ ADD A DEVICE" on the menu.

It will now detect the device and ask you to enter your wifi Network ID and password. Go ahead enter your network ID and password. (note: 5G networks are not supported. network ID and password are case-sensitive)

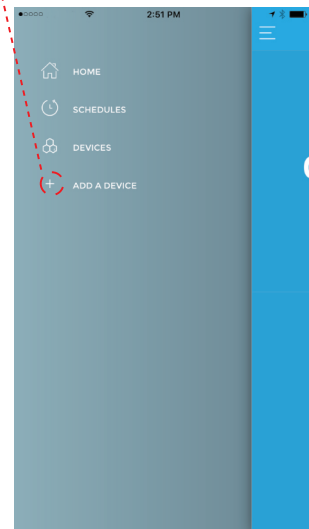
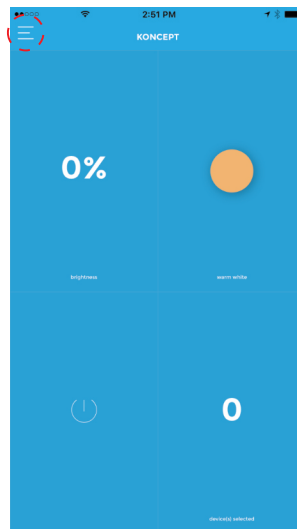

## Connect through WPS

If the methods above do not work for you, you may try connecting through WPS.

You should notice a slowly blinking blue LED on the wifi module, which means it is in AP mode ready for setup.

While the Blue LED is blinking slowly, press and hold the button on the back of the Wifi module for 10 seconds.

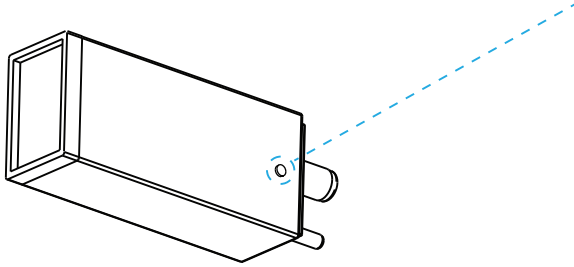

After the button is released, the wifi module will enter WPS mode and the blue led will now blink rapidly.

Press the WPS button on the router, and wait for the wifi module to connect to the router.

Once the wifi module is connected, the blue LED will become solid.

## Resetting Wi-Fi connection

To set the module back to "AP state" for Wi-Fi connection setup, press and hold the button on the back of the wifi module for 20 seconds. After the button is released, the Blue LED should blink slowly, which indicates that it is ready to accept Wi-Fi connection. Repeat setup steps in Step 3.

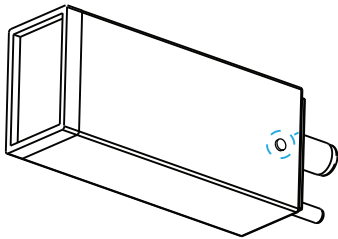

#### 4 Configure your UCX pro lights

Once you have completed setting up the UCX pro WIFI module, you are ready to configure your UCX pro lights using the Koncept app. Now open the Koncept app.

Click on the menu icon at the top left corner, select "DEVICES" on the menu. Click on the check box to select the device.

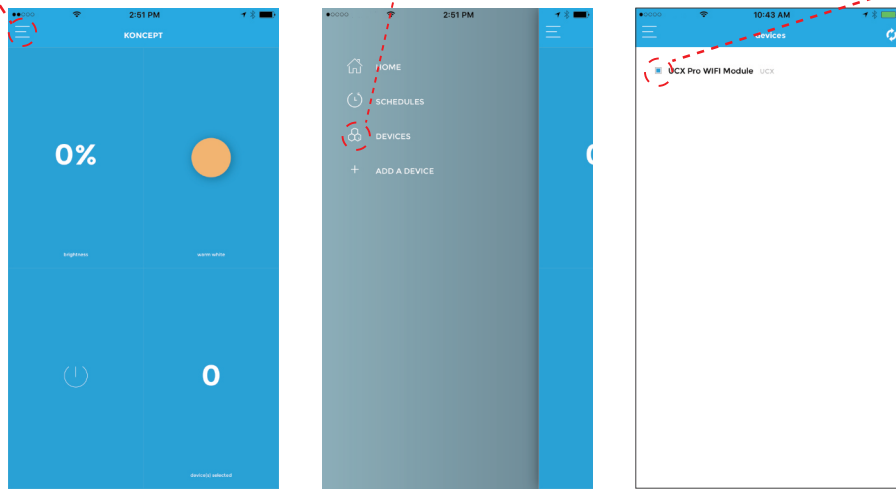

(Optional steps) Click on the name of the device to edit settings, an "edit device" page will show up.

Rename device : You may rename the device by clicking onto the name of device, rename it to something easy to recognize.

Lock device - On the network this device will be displayed as locked, and can only be unlocked by having physical access.

Firmware upgrade : When there is a new release of firmware, an upgrade button will show and you may click to upgrade.

Power consumption : You can see an estimation of the power consumed since the installation. Hit reset would restart the estimation.

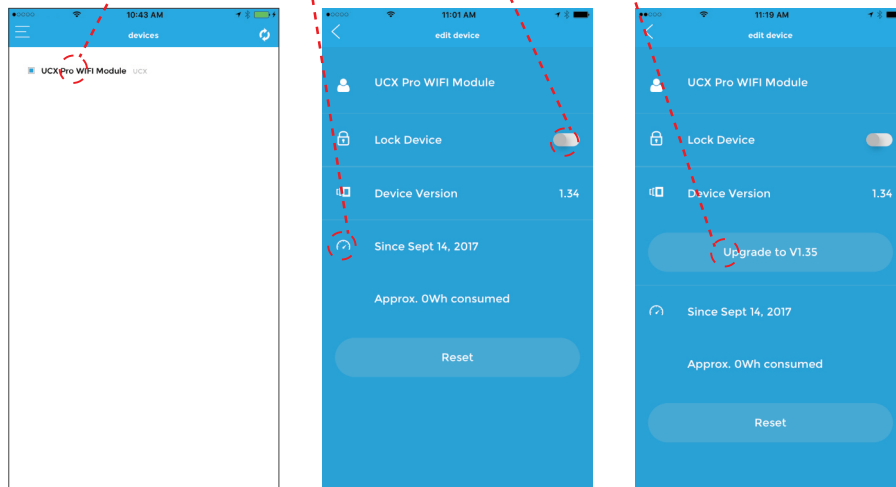

Click on the menu icon at the top left corner, select "HOME" on the menu, this will bring you back to the home page.

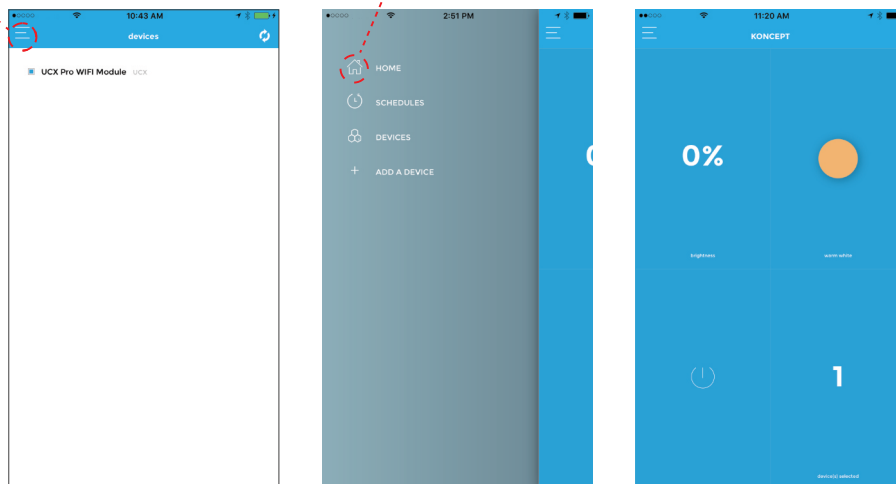

You should notice count of the "device(s) selected" at the lower right corner has changed to 1.

## 5 Basic Control

To adjust brightness, click on the upper left icon to open the brightness control, you may start dialing around the circle to adjust brightness. Once you are done, click back < icon at the upper left to return to home page.

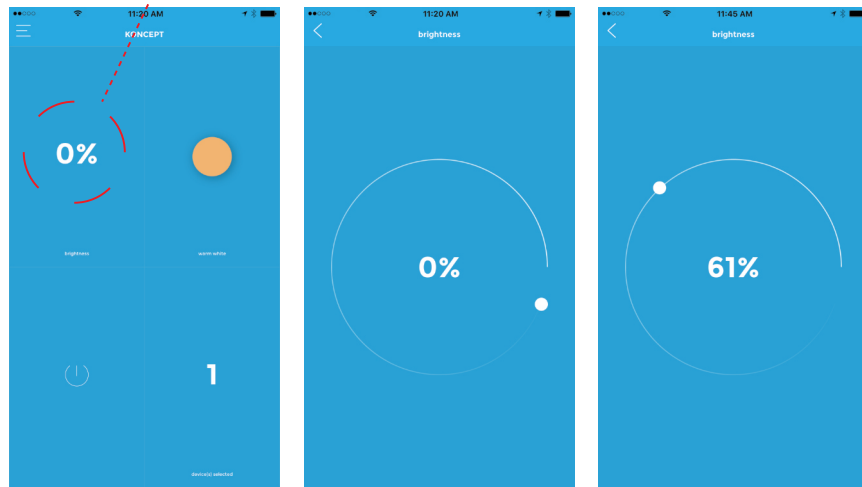

To light color, click on the upper right icon to open the color control, you may start dialing around the circle to adjust light color. Once you are done, click back < icon at the upper left to return to home page.

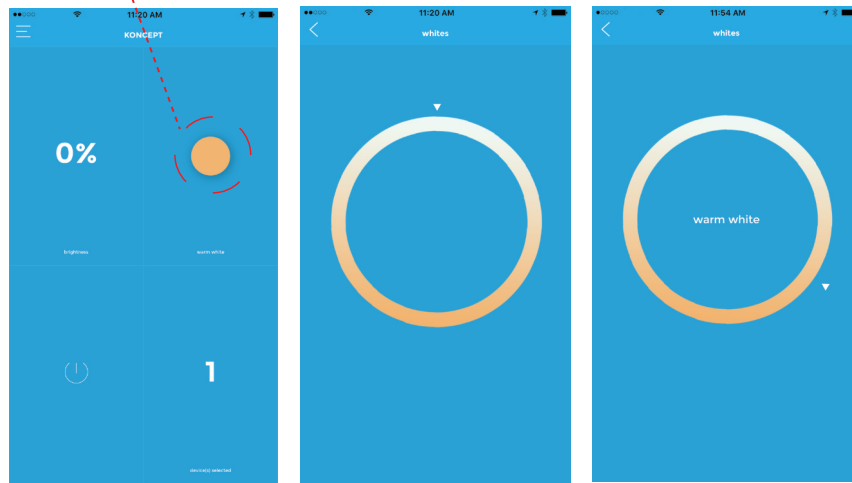

The power icon on the lower right can be used as a toggle ON/OFF control.

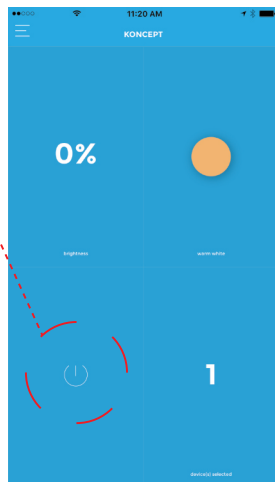

## 6 Advanced Control (Scheduling)

You may set specific time to turn the lamp on/off/dim, according to your schedule throughout the week. Multiple users sharing the same UCX pro could each set their schedule to have the light on at the timing they use the desk.

**Circadian light :** UCX pro has the capability to change light color. Besides just being a personal preference on the color, you can customize a light color schedule to help shift your circadian rhythm to its normal pattern, automatically everyday.

Circadian rhythm is like an internal “Clock” in the brain that regulates the timing of sleepiness and wakefulness throughout the day. It is suggested that having warm light at afternoon/night with cool light in the morning helps ease the body into and out of sleep in order to create your own perfect sleep cycle.

Click on the menu icon at the top left corner, select “SCHEDULES” on the menu, this will bring you to the schedules page.

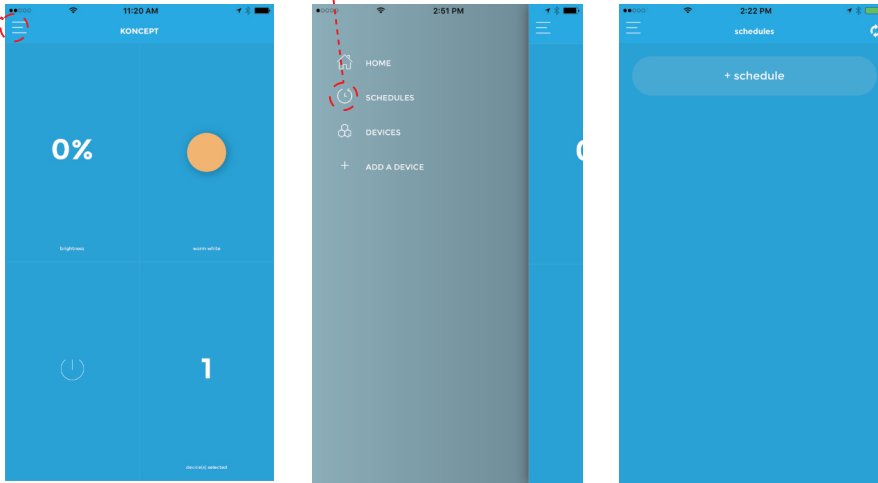

Click on the “+ schedule” to create new schedule. A default 12:00pm schedule will be created, click on it to go to the “settings” page. Click on the lower right icon to go to the “devices” page and select the device that you want to edit, click the back < icon to go back.

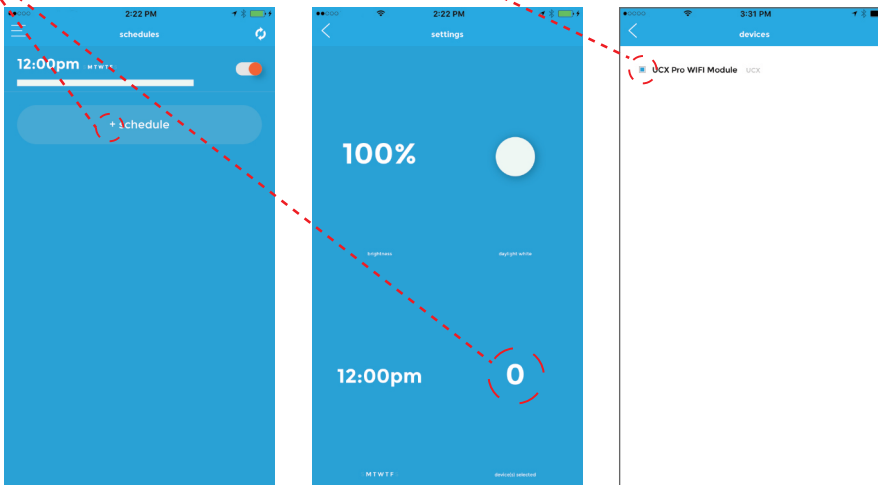

Click on the lower left timing icon to go to the “set time” page. Select the preferred am/pm, time and the days of the week, then hit the back < button. Choose the brightness and light colors. Once Brightness, Light color and timing are all set, hit the back < button to go back to the “schedules” page. You may create as many schedules as you like by repeating the process.

