



Floor

Streamlined Flexibility

Z-Bar floor lamp

Z-Bar Gen 4 Floor Lamp's design features greater energy efficiency, brighter light and improved optics than previous Z-Bar generation. The joint mechanisms are now flush to the slim body, making for a cleaner profile and allowing for even greater articulation. Z-Bar Floor maintains its beloved characteristics, such as diffused and dimmable light, and the iconic three-bar design. It allows users to choose and adjust their color temperatures (from 2,700-5,000 K) to coincide with their circadian rhythms. It also comes with an occupancy sensor to turn the lamp on/off automatically to further save energy.

Designers

Peter Ng, Kenneth Ng, Edmund Ng

Red Dot Design Award 2021

iF Design Award 2021

Best of NeoCon SILVER 2021

Interior Design Magazine's Best of Category 2006*

Permanent display at Die Neue Sammlung, Munich*

TIME Magazine's Best Inventions of the Year 2007*

*Awards won with previous Z-bar generations

Technical Information

	Z-Bar Floor
Occupancy Sensor:	Built-in
USB-C port:	N/A
Color Temperature:	2,700K (S) - 5000K (D)
Lumens:	816 (S) / 971 (D)
Footcandles @ 15":	206
Energy Consumption:	10.1 W
Standard Finishes:	Matte Black, Silver, Matte White, Brush Nickel
L-90 Rated Lifespan:	60,000 hours
Color Rendering Index:	90+
Brightness Adjustability:	Continuous dimming (touchstrip)
Material:	Aluminum, plastic
Safety Rating:	C-UL-US Certified
Warranty:	5 years (U.S. & Canada). <i>For international regions, consult local distributor.</i>
Voltage:	100-240V

Z-Bar Floor

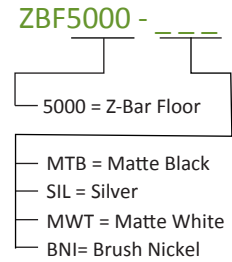

Dimensions

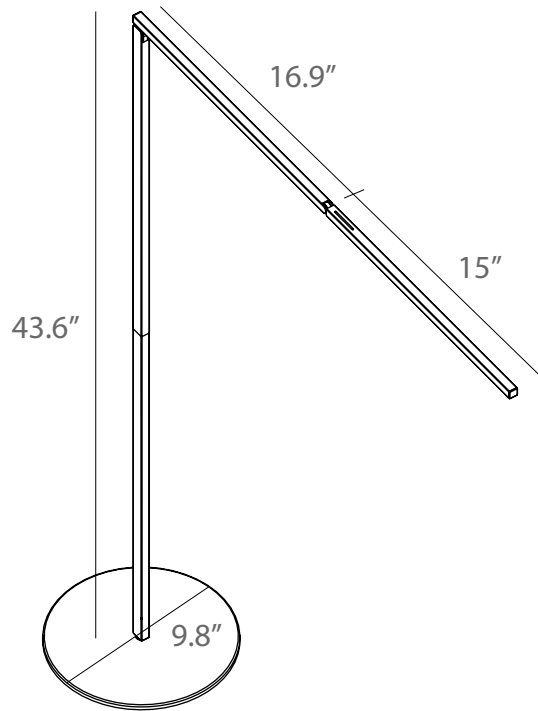

LEED Information

Integrative Process

To support high-performance, cost-effective project outcomes through an early analysis of the interrelationships among systems.

Koncept's LED desktop and task lighting provides finer control over lighting levels in occupied spaces. With personal lighting in place, elimination or downsizing of building lighting systems is possible.

Interior Lighting

To promote occupants' productivity, comfort and well-being by providing high-quality lighting.

Koncept's portable task lighting products provide more than three lighting levels that occupants can easily adjust to suit their needs. Furthermore, all Koncept lighting products use high quality LED light sources with CRI over 90 and L90 rated lifespan over 60,000 hours. Desktop and task personal lighting also provide the opportunity to reduce overhead lighting.

Photometrics: Light source placed 15" away from work surface

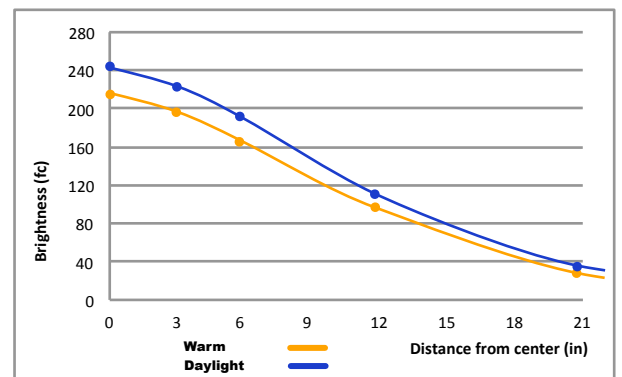

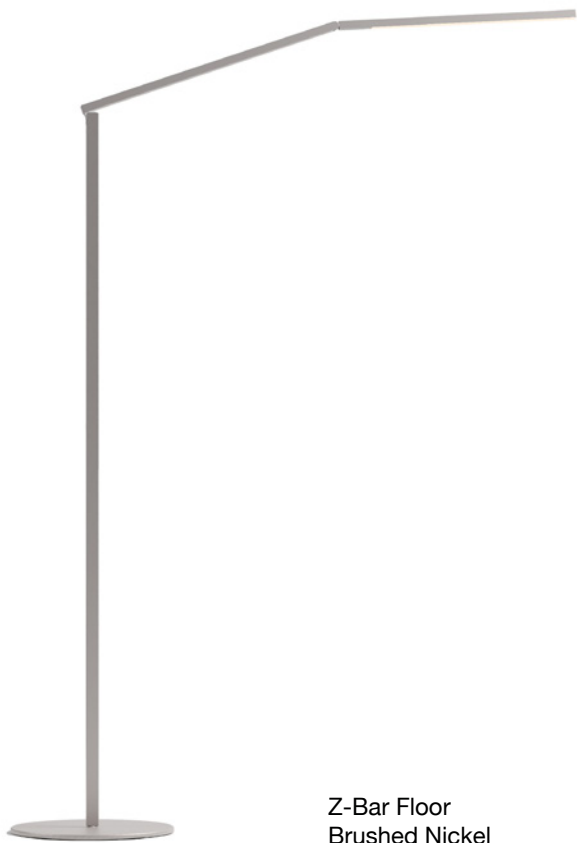

Z-Bar Floor
Brushed Nickel

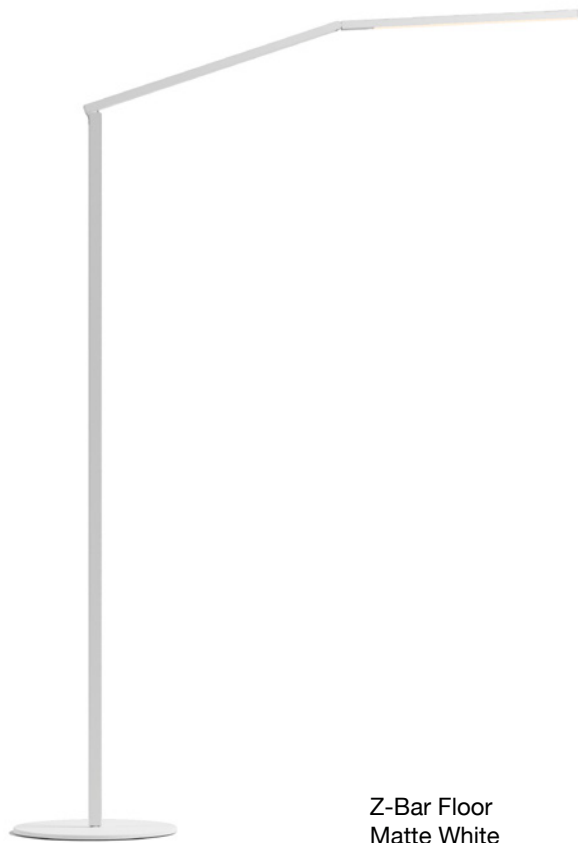

Z-Bar Floor
Matte White

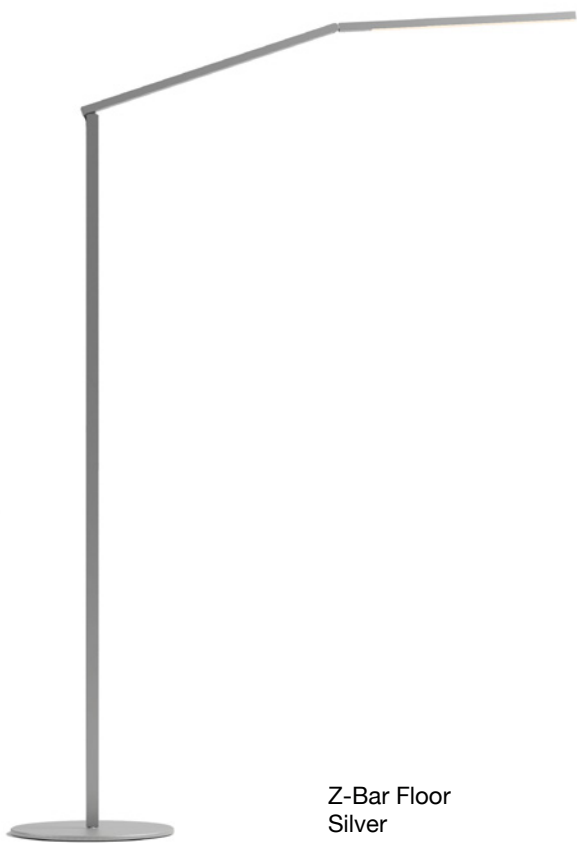

Z-Bar Floor
Silver

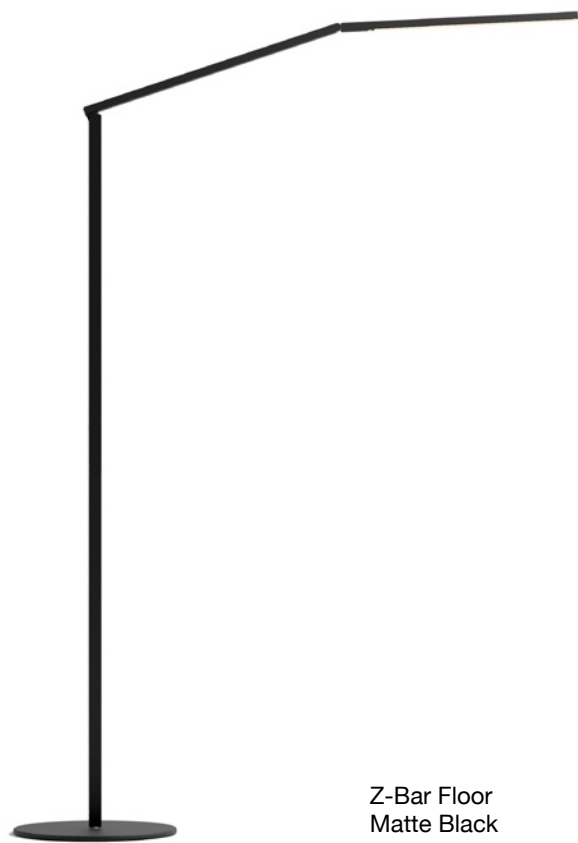

Z-Bar Floor
Matte Black