



koncept

Modular LED lighting system

Z-Bar pendant

Designers
Kenneth Ng, Edmund Ng

Best of NeoCon GOLD 2016
iF Design Award 2017
Red Dot Design Award 2017

The award-winning Z-Bar Pendant line is a flexible LED lighting system. Multiple standard shapes are available, including the renowned "Bird" and tiered "Rise." These standard shapes can be built upon to create customized installations, such as the connected Honeycombs displayed above. Designers can also abandon all pre-configured profiles and create original designs based on their preferences or project requirements. The Z-Bar Pendant lighting system gives a huge range of artistic freedom.

The entire suspension system consists of modular LED light bars, power-conducting dummy bars, specialized "plug and play" joints, barely-there suspending wires and power for remote or canopy installations. Each LED light bar rotates independently, allowing you to shine light upwards for ambience or downwards for tasks. Utilize the dedicated web application and/or assistance from Koncept's sales team to create custom configurations. Many Z-Bar Pendant shapes are compatible with Koncept's line of acoustic panels.

Overview

Lumens:	Approximately 300 per ft
Energy Consumption:	Approximately 5 W per ft of LED light
Rated Lifespan:	>60,000 hours
Color Temperature:	3,000 K
CRI:	90
Brightness Adjustability:	Continuous dimming (for list of compatible dimmers, visit koncept.com/dimmers)
Safety Rating:	C-UL-US Certified, CE
Warranty:	5 years / 1 year for driver specifically
Voltage:	120 V (Custom 277V option available, ask for details)
Standard Finishes:	Matte black, matte white, silver, gold
Photometrics:	For current IES files visit koncept.com/zbarpendant
Standard Pre-Configured Designs:	Bird, Honeycomb, Linear, Square, Triangle, Rectangle, Trio, Cross, Crown, Zig-Zag, Tri-Star, Quad-Star, Rise Rectangle, Rise Square
Custom Configurations:	Use our free online configurator (visit koncept.com/SpecOnline) or contact sales@koncept.com

Visit koncept.com/dimmers for information on compatible dimmers.
 Remote transformers are only compatible with 1-10V dimmers.
 Remote transformers are sold separately and are only available for multipoint installation.

Construction

LED light bars / Dummy bars

Available in matte black, matte white, silver, gold
 LED light bars are rotatable
 Dummy bars conduct power and do not emit light



Standard LED light bars

Length*	Watts	Lumens
16"	5	400
24"	8	600
36"	13	900
48"	17	1200

*Length represents both light bars and dummy bars

Connecting joints with suspending wires

"Plug and play"

Joint finishes match the overall configuration
 Wires are slim, silver and 10' in length
 Some suspending wires contain power

Please note: To create custom configurations, the Z-Bar Pendant Online Configurator must be used, or the Koncept Sales team must be contacted for assistance. Standard Z-Bar Pendant units cannot be manually connected to each other.

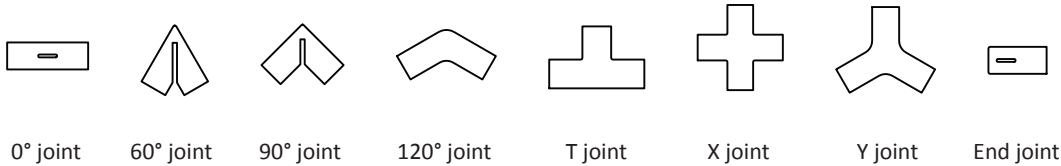

Power transformers

For canopy or remote installation
 Remote Transformer is recommended for any configuration requiring more than 40 W energy consumption.
 Koncept's sales team will work with you to choose the most appropriate power/mounting option.
 Power control options: PMW dimmers / 1-10V control
 For list of compatible dimmers, visit koncept.com/dimmers

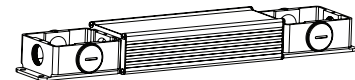

Acoustic Panels

Optional. Vertical or horizontal mounts, 10 finishes.

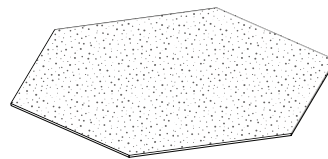

LEED information

Integrative Process

To support high-performance, cost-effective project outcomes through an early analysis of the interrelationships among systems.
 Koncept's LED lighting fixtures operate at high efficacy, therefore helping to minimize energy costs. All Koncept lighting fixtures are dimmable so that occupants can choose the appropriate setting to avoid energy overuse.

Interior Lighting

To promote occupants' productivity, comfort and well-being by providing high-quality lighting.
 Koncept's entire line of hardwired lighting fixtures are dimmable. Users can adjust the brightness settings to suit their needs. Furthermore, all products utilize high quality LED light sources with CRI over 80 and L90 rated lifespan over 60,000 hours.



On GSA schedule

Photometrics diagram
Z-Bar pendant

Z-Bar pendant (16 inch LED light bar)

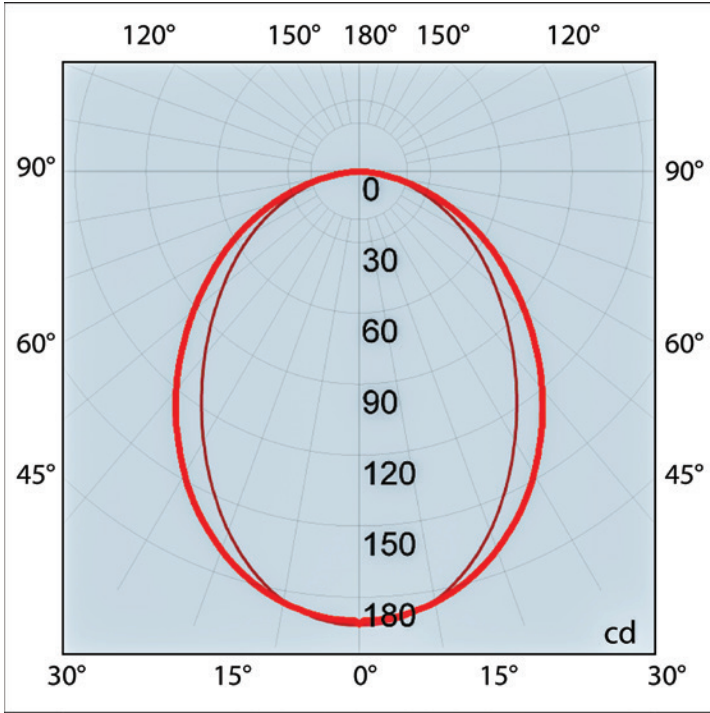

Z-Bar pendant (24 inch LED light bar)

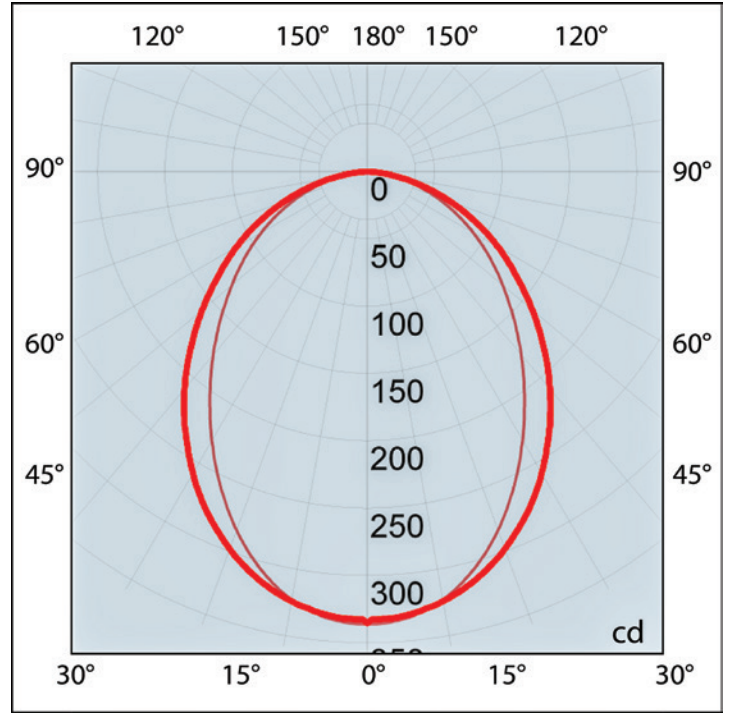

Z-Bar pendant (36 inch LED light bar)

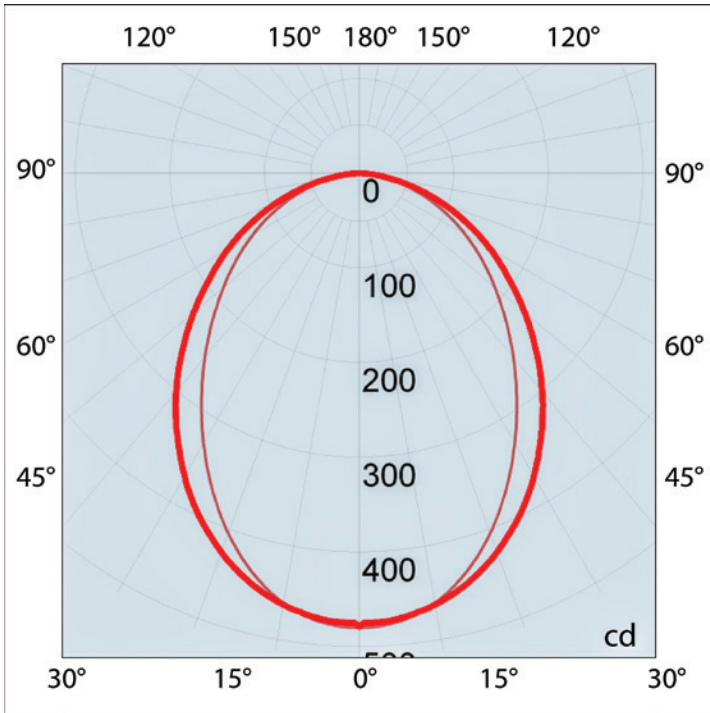

Z-Bar pendant (48 inch LED light bar)

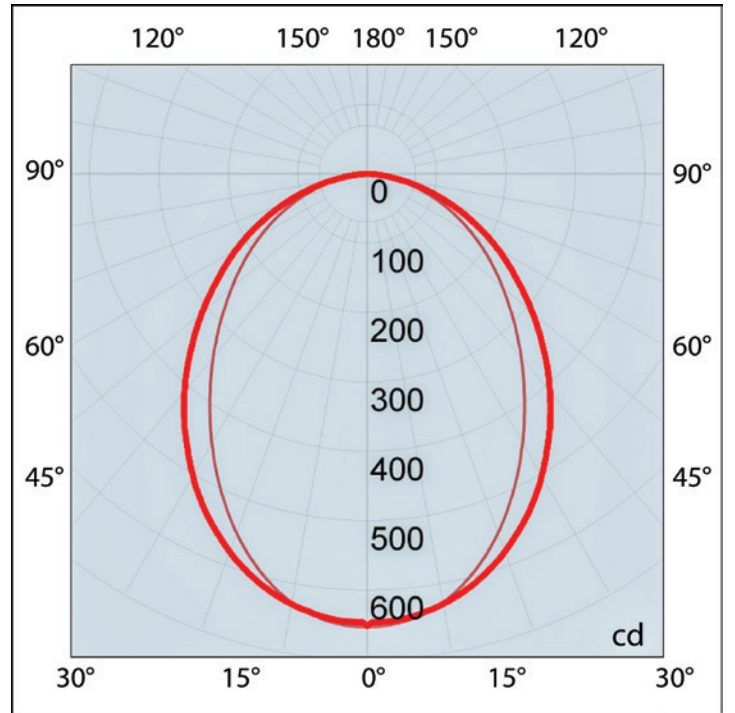

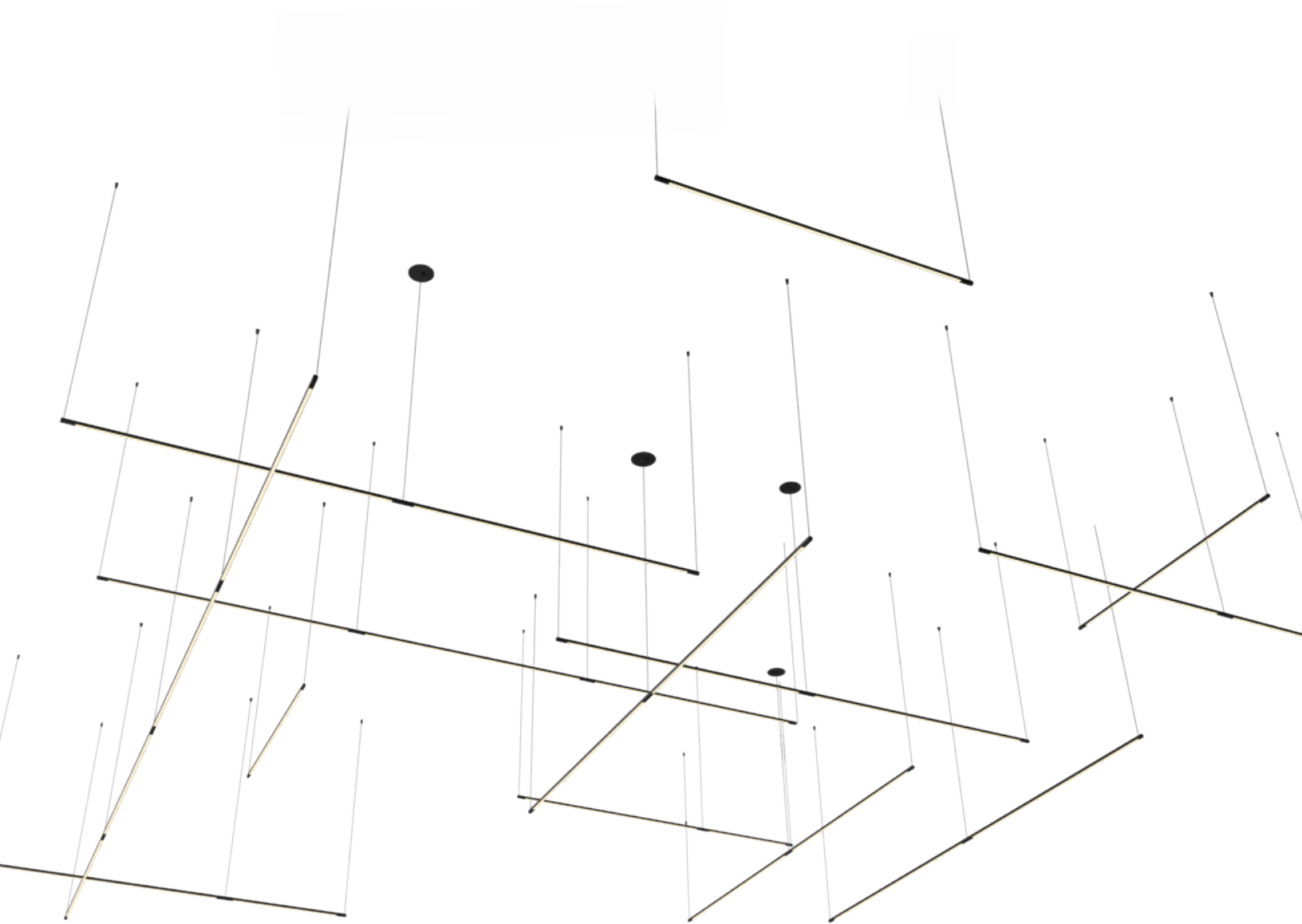

Z-Bar pendant

Custom Configurations

Designers can create custom systems based on their ideas or project requirements. Utilize Koncept's dedicated web application at koncept.com/speonline, along with the assistance of our sales team. Take a look at the resources on the following pages for inspiration, instructions and order examples.

Custom Configurations

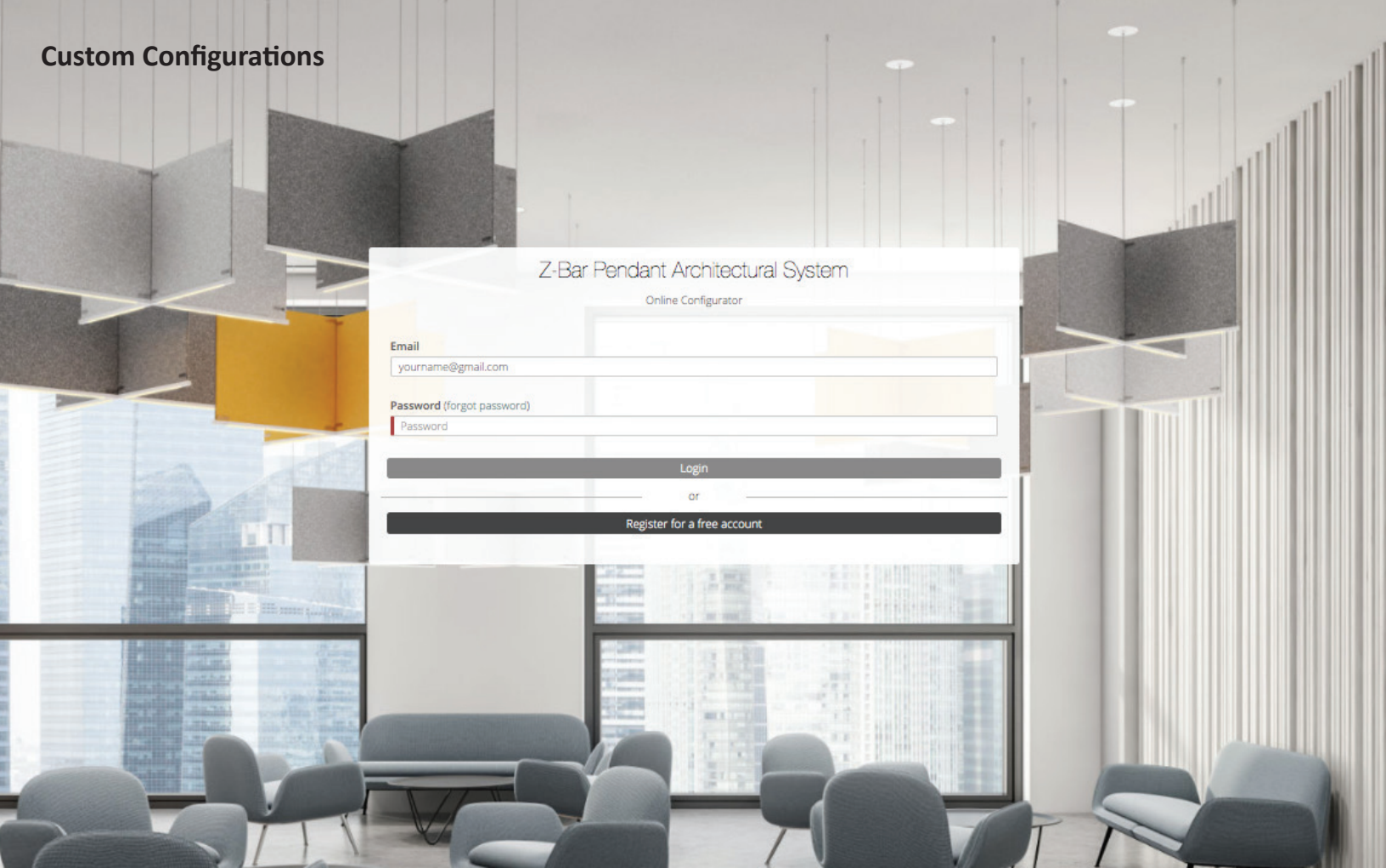

Log into koncept.com/speonline and create a free account.
Download the [Z-Bar Pendant Configurator Overview Manual](#) for reference.
Contact sales@koncept.com for assistance.

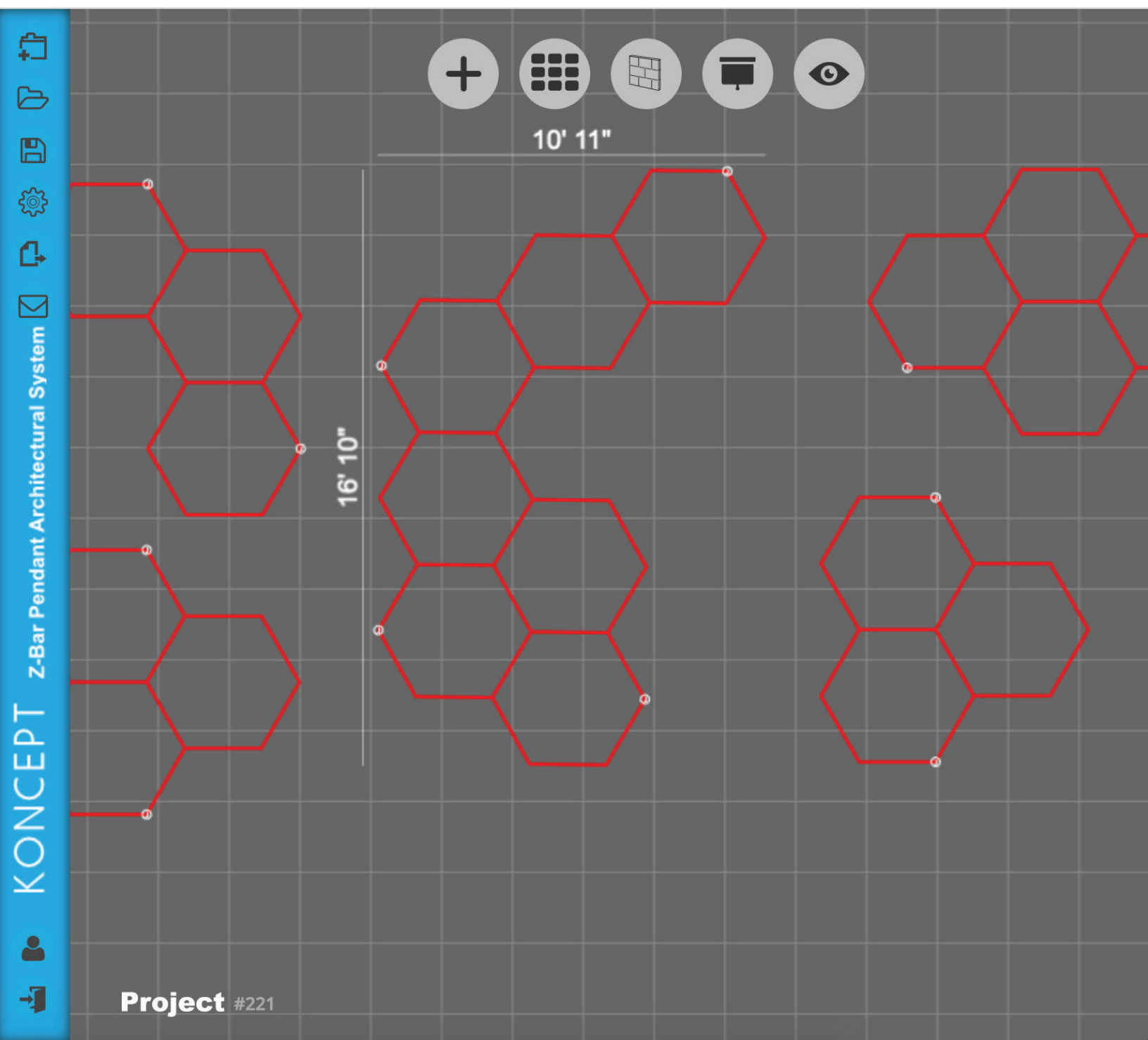

Create geometric designs with angular and dimensional notation. Define your space with walls, work with multiple layers and view in 3D to get the best visualization of the installation(s) in real life.

Custom Configurations



Image of custom configuration

Custom Configurations

- lumens: Approximately 300 per ft
- Energy Consumption: Approximately 5 W per ft of LED light
- Rated Lifespan: >60,000 hours
- Color Rendering Index (CRI) : 90
- Brightness Adjustability: For CNP Option : Compatible with ELV wall dimmers
For RTM Option : 1 – 10V dimming control only
- Material: Aluminum, plastic
- Cable length: 10'
- Safety Rating: C-UL-US Certified, CE
- Warranty: 5 years; 1 year for hardwire driver
- Voltage: 120 V (Custom 277V option available, ask for details). The Z-Bar pendant system is powered at 24Vdc and limited to a maximum current of 4A and a maximum power of 81.6W.
- Standard Finishes: Matte black, matte white, silver, gold

Visit koncept.com/dimmers for information on compatible dimmers.
Remote transformers are only compatible with 1-10V dimmers.
Remote transformers are sold separately and are only available for multipoint installation.

How to specify

- Utilize the free online configurator at koncept.com/speconline
- Using the specification charts below, choose an option from each column and enter into the appropriate fields at the bottom.
- Submit the "SKUs" to sales@koncept.com, along with any questions.

Specification charts

Specify the following parts individually:

- LED light bars
- Connecting joints
- Power
- Acoustic panels (optional)

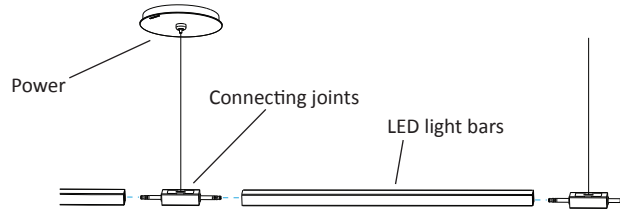

LED light bars

	Light Bar Length (in)	Light Temperature (K)	Finish
P1 - ZBP	16	2,700*	Silver (SIL)
	24	3,000 (SW)	Matte black (MTB)
	36	3,500*	Matte white (MWT)
	48	4,000*	Gold (GLD)
		4,500*	
		5,000*	
		dummy bar (DB)	

Order example: **P1-ZBP** - **24** - **SW** - **SIL**

*Non -stocked item
Additional lead time/charges may be applied to non-stocked options

Dimensions

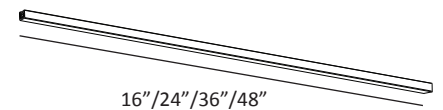

Cross section of all LED light bars

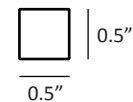

Custom Configurations

Connecting joints

Linear joint

	Power	Connection	Angle	Finish	Flat	Layer
P6 - ZBP	Input (I) No power (N) Transmit power (T)	2-point (C) End (E)	000	Silver (SIL) Matte black (MTB) Matte white (MWT) Gold (GLD)	F	Top (T) Bottom (B) Default joints are for the bottom layer. Top layer joints are intended for wires to pass through

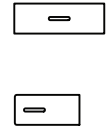

Order example: P6-ZBP - I - C - 000 - SIL - F - B

Right angle joint

	Power	Connection	Angle	Finish	Flat	Layer
P6 - ZBP	Input (I) No power (N) Transmit power (T)	2-point (C) End (E)	090	Silver (SIL) Matte black (MTB) Matte white (MWT) Gold (GLD)	F	Top (T) Bottom (B) Default joints are for the bottom layer. Top layer joints are intended for wires to pass through

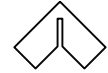

Order example: P6-ZBP - I - C - 090 - GLD - F - B

60° angle joint

	Power	Connection	Angle	Finish	Flat	Layer
P6 - ZBP	Input (I) No power (N) Transmit power (T)	2-point (C) End (E)	060	Silver (SIL) Matte black (MTB) Matte white (MWT) Gold (GLD)	F	Top (T) Bottom (B) Default joints are for the bottom layer. Top layer joints are intended for wires to pass through



Order example: P6-ZBP - T - C - 060 - MTB - F - B

120° angle joint

	Power	Connection	Angle	Finish	Flat	Layer
P6 - ZBP	Input (I) No power (N) Transmit power (T)	2-point (C) End (E)	120	Silver (SIL) Matte black (MTB) Matte white (MWT) Gold (GLD)	F	Top (T) Bottom (B) Default joints are for the bottom layer. Top layer joints are intended for wires to pass through

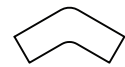

Order example: P6-ZBP - T - C - 120 - SIL - F - B

X joint

	Power	Connection	Angle	Finish	Flat	Layer
P6 - ZBP	Input (I) No power (N) Transmit power (T)	Cross (X)	090	Silver (SIL) Matte black (MTB) Matte white (MWT) Gold (GLD)	F	Top (T) Bottom (B) Default joints are for the bottom layer. Top layer joints are intended for wires to pass through

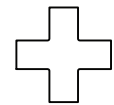

Order example: P6-ZBP - I - X - 090 - MWT - F - B

T joint

	Power	Connection	Angle	Finish	Flat	Layer
P6 - ZBP	Input (I) No power (N) Transmit power (T)	Trio (T)	090	Silver (SIL) Matte black (MTB) Matte white (MWT) Gold (GLD)	F	Top (T) Bottom (B) Default joints are for the bottom layer. Top layer joints are intended for wires to pass through

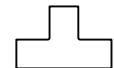

Order example: P6-ZBP - I - T - 090 - MWT - F - B

Custom Configurations

Y joint

	Power	Connection	Angle	Finish		Layer
P6 - ZBP	Input (I) No power (N) Transmit power (T) Transmit power at only 2 ends (T2)	Trio (T)	120	Silver (SIL) Matte black (MTB) Matte white (MWT) Gold (GLD)	F	Top (T) Bottom (B) Default joints are for the bottom layer. Top layer joints are intended for wires to pass through



Order example: P6-ZBP - I - T - 120 - MWT - F - B

Power

Canopy
(transformer is inside the canopy)

	Number of slots (for suspending wires)		Power	Finish	
P8 - ZBP	1 3 4 6	24	0166	Silver (SIL) Matte black (MTB) Matte white (MWT) Gold (GLD)	CNP

Order example: P8-ZBP - 4 - 24 - 0166 - MWT - CNP

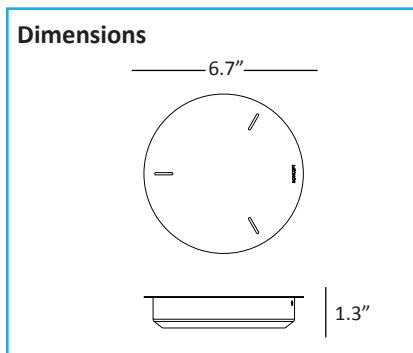

Remote Transformer
(transformer placed in ceiling. Cover plate for ceiling included)

	Number of slots (for suspending wires)		Power	Finish	
P8 - ZBP	1	24	0340	Silver (SIL) Matte black (MTB) Matte white (MWT) Gold (GLD)	RTM

Order example: P8-ZBP - 1 - 24 - 0340 - MWT - RTM

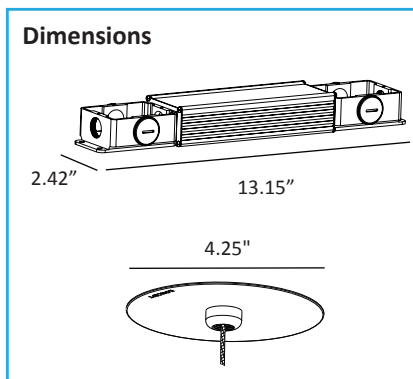

Acoustic panels

Please see acoustic panels specification sheet for more information or visit koncept.com/acousticpanels

LEED information

Integrative Process

To support high-performance, cost-effective project outcomes through an early analysis of the interrelationships among systems. Konzept's LED lighting fixtures operate at high efficacy, therefore helping to minimize energy costs. All Konzept lighting fixtures are dimmable so that occupants can choose the appropriate setting to avoid energy overuse.

Interior Lighting

To promote occupants' productivity, comfort and well-being by providing high-quality lighting.

Koncept's entire line of hardwired lighting fixtures are dimmable. Users can adjust the brightness settings to suit their needs. Furthermore, all products utilize high quality LED light sources with CRI over 80 and L90 rated lifespan over 60,000 hours.



On GSA schedule

KONCEPT



Z-Bar pendant *cross*

Standard Configuration with Expandability

The Z-Bar pendant cross utilizes an "X" joint to create an instantly classic shape. Available in three standard finishes and two standard sizes, it is compatible with Koncept's vertical acoustic panels. The cross can be suspended solo or "expanded" by combining multiple into custom grid-like arrangements. Utilize Koncept's dedicated web application to create custom projects.

Standard Configurations



cross with 16" light bars

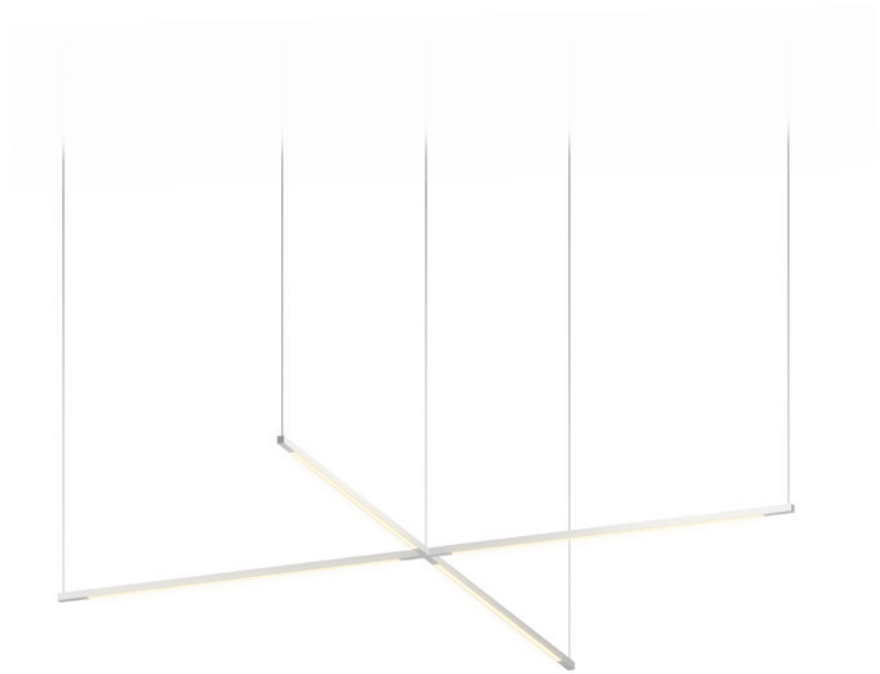

cross with 24" light bars

Standard Configurations

Lumens: 16-CS: 1600 / 24-CS: 2400
Energy Consumption: 16-CS: 28 W / 24-CS: 40 W
Rated Lifespan: >60,000 hours
Color Rendering Index (CRI) : 90
Brightness Adjustability: For CNP Option : Compatible with ELV wall dimmers
 For RTM Option : 1 – 10V dimming control only
Material: Aluminum, plastic
Cable length: 10'
Safety Rating: C-UL-US Certified, CE
Warranty: 5 years; 1 year for hardwire driver
Voltage: 120 V (Custom 277V option available, ask for details)
Standard Finishes: Matte black, silver, gold

Visit koncept.com/dimmers for information on compatible dimmers.
 Remote transformers are only compatible with 1-10V dimmers.
 Custom installations using multiple pendants will utilize a remote transformer as opposed to a canopy mount.

Power placement

There are two ways to mount the Z-Bar pendant cross using the canopy: monopoint installation or multipoint installation. The same parts are used for each installation method.

Remote transformers are sold separately and are only available for multipoint installation.

Monopoint installation

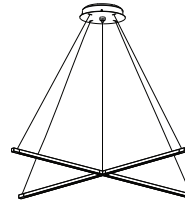

Multipoint installation

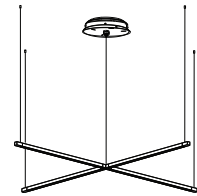

Dimensions

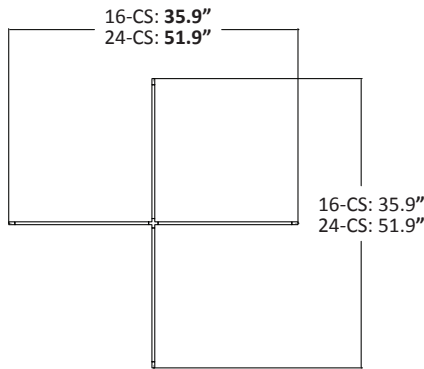

Canopy

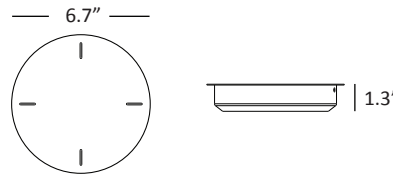

Remote Transformer

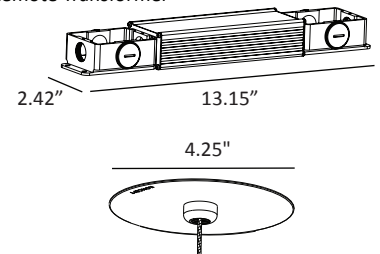

How to specify

1. Choose an option from each column and enter into the appropriate fields at the bottom.
2. Submit this "SKU" to sales@koncept.com, along with any questions.

ZBP	Light Bar Length (in) (this is length of each light bar, NOT length of fixture.)	Model	Light Temperature (K)	Finish	Mount
	16	CS	2,700*	Silver (SIL)	Canopy (CNP)**
	24		3,000 (SW)	Matte Black (MTB)	Remote Transformer (RTM)**
	36*		3,500*	Gold (GLD)	
	48*		4,000*	Matte White (MWT)*	
			4,500*		
			5,000*		

Order example: ZBP - 24 - CS - SW - SIL - RTM

*Custom

**Remote Transformer is recommended for any configuration requiring more than 40 W energy consumption.

Additional lead time/charges may be applied to non-stocked options

LEED information

Integrative Process

To support high-performance, cost-effective project outcomes through an early analysis of the interrelationships among systems. Konzept's LED lighting fixtures operate at high efficacy, therefore helping to minimize energy costs. All Konzept lighting fixtures are dimmable so that occupants can choose the appropriate setting to avoid energy overuse.

Interior Lighting

To promote occupants' productivity, comfort and well-being by providing high-quality lighting.

Koncept's entire line of hardwired lighting fixtures are dimmable. Users can adjust the brightness settings to suit their needs. Furthermore, all products utilize high quality LED light sources with CRI over 80 and L90 rated lifespan over 60,000 hours.



On GSA schedule

Standard Configurations with Expandability



Sample rendering of a Z-Bar pendant cross custom configuration

Standard Configurations with Expandability

These are many possible custom configurations based on pre-configured designs. Below are samples of what can be specified. For fully custom configurations, please see the Custom Configurations section.

CS2

The CS2 consists of two crosses merging together at two points.

Lumens: 16-CS2: 3200 / 24-CS2: 4800 / 36-CS2: 5400 / 48-CS2: 10400
 Energy Consumption: 16-CS2: 56 W / 24-CS2: 80 W / 36-CS2: 90 W / 48-CS2: 160 W

Order Example: **ZBP-36-CS2-SW-GLD-RTM**

Dimensions

16-CS2: 53.85"
 24-CS2: 77.85"
 36-CS2: 116.75"
 48-CS2: 155.5"

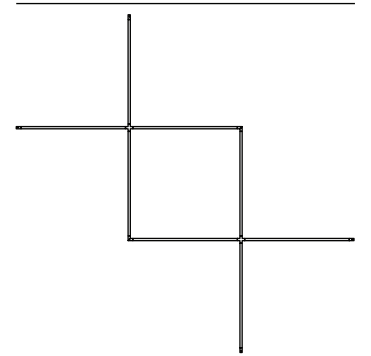

16-CS2: 53.85"
 24-CS2: 77.85"
 36-CS2: 116.75"
 48-CS2: 155.5"

CS3

The CS3 consists of three crosses merging together at two points. The center cross is diagonally angled between the other two.

Lumens: 16-CS3: 4800 / 24-CS3: 7200 / 36-CS3: 10800 / 48-CS3: 15600
 Energy Consumption: 16-CS3: 84 W / 24-CS3: 120 W / 36-CS3: 180 W / 48-CS3: 240 W

Order Example: **ZBP-48-CS3-SW-SIL-RTM**

16-CS3: 89.48"
 24-CS3: 129.87"
 36-CS3: 194.8"
 48-CS3: 249.16"

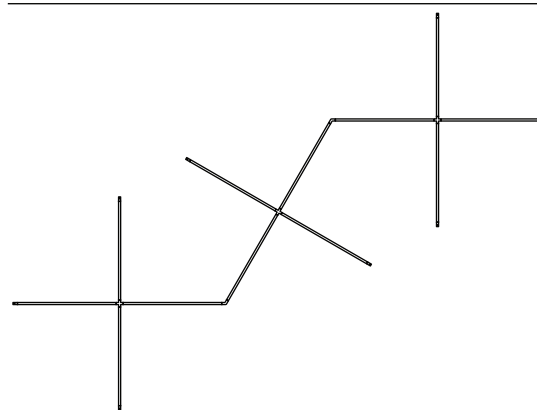

16-CS3: 66.85"
 24-CS3: 97"
 36-CS3: 145.5"
 48-CS3: 186.14"

How to specify

1. Utilize the free online configurator at koncept.com/speconline.
2. Choose an option from each column and enter into the appropriate fields at the bottom.
3. Submit this "SKU" to sales@koncept.com, along with any questions.

	Light Bar Length (in) (this is length of each light bar, NOT length of fixture.)	Model	Light Temperature (K)	Finish	Mount
ZBP		CS2 CS3	2,700* 3,000 (SW) 3,500* 4,000* 4,500* 5,000*	Silver (SIL) Matte Black (MTB) Gold (GLD) Matte White (MWT)*	Remote Transformer (RTM)
	16 24 36* 48*				

Order example: **ZBP - 24 - CS2 - SW - SIL - RTM**

*Custom

Remote Transformer is recommended for any configuration requiring more than 40 W energy consumption. Additional lead time/charges may be applied to non-stocked options

LEED information

Integrative Process

To support high-performance, cost-effective project outcomes through an early analysis of the interrelationships among systems.

Koncept's LED lighting fixtures operate at high efficacy, therefore helping to minimize energy costs. All Koncept lighting fixtures are dimmable so that occupants can choose the appropriate setting to avoid energy overuse.

Interior Lighting

To promote occupants' productivity, comfort and well-being by providing high-quality lighting.

Koncept's entire line of hardwired lighting fixtures are dimmable. Users can adjust the brightness settings to suit their needs. Furthermore, all products utilize high quality LED light sources with CRI over 80 and L90 rated lifespan over 60,000 hours.



On GSA schedule



Z-Bar pendant *honeycomb*

Standard Configuration with Expandability

The Z-Bar pendant honeycomb is a contemporary pendant in a hexagonal shape. Available in two standard sizes and four standard finishes, it can be enjoyed as a stand-alone configuration, or can be “expanded” into custom arrangements. Utilize Koncept’s dedicated web application to join multiple honeycombs together or combine with other Z-Bar Pendants. The distinctive pendant is compatible with Koncept’s line of horizontal and vertical acoustic panels.

Standard Configurations

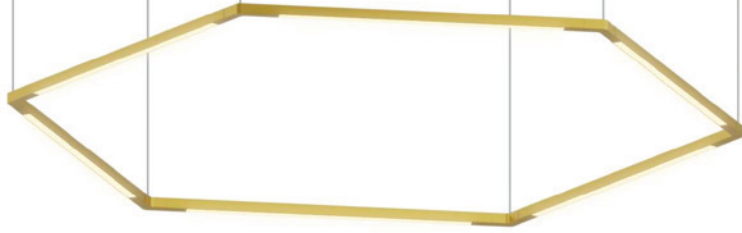

Honeycomb (with 16" light bars)

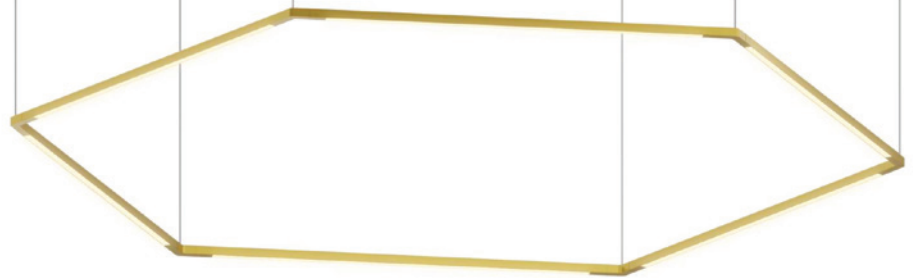

Honeycomb (with 24" light bars)

Standard Configurations

Lumens:	16-H: 2400 / 24-H: 3600
Energy Consumption:	16-H: 30 W / 24-H: 40 W
Rated Lifespan	>60,000 hours
Color Rendering Index (CRI) :	90
Brightness Adjustability:	For CNP Option : Compatible with ELV wall dimmers For RTM Option : 1 – 10V dimming control only
Material:	Aluminum, plastic
Cable length:	10'
Safety Rating:	C-UL-US Certified, CE
Warranty:	5 years; 1 year for hardwire driver
Voltage:	120 V (Custom 277V option available, ask for details)
Standard Finishes:	Matte black, matte white, gold, silver

Visit koncept.com/dimmers for information on compatible dimmers.
Remote transformers are only compatible with 1-10V dimmers.
Custom installations using multiple pendants will utilize a remote transformer as opposed to a canopy mount.

Power placement

There are two ways to mount the Z-Bar pendant Honeycomb using the canopy: monopoint installation or multipoint installation.

Remote transformers are sold separately and are only available for multipoint installation.

Monopoint installation

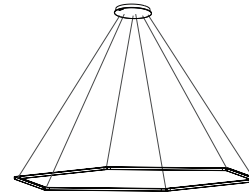

Multipoint installation

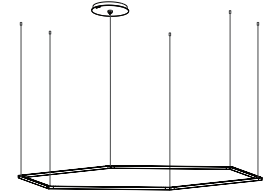

How to specify

1. Choose an option from each column and enter into the appropriate fields at the bottom.
2. Submit this "SKU" to sales@koncept.com, along with any questions.

ZBP	Light Bar Length (in) (this is length of each light bar, NOT length of fixture.)	H H	Light Temperature (K)	Finish	Mount
	16		2,700*	Silver (SIL)	Canopy (CNP)**
	24		3,000 (SW)	Matte Black (MTB)	Remote Transformer (RTM)**
	36*		3,500*	Gold (GLD)	
	48*		4,000*	Matte White (MWT)*	
			4,500*		
			5,000*		

Order example: ZBP - 16 - H - SW - SIL - RTM

*Custom

**Remote Transformer is recommended for any configuration requiring more than 40 W energy consumption

Additional lead time/charges may be applied to non-stocked options

Dimensions

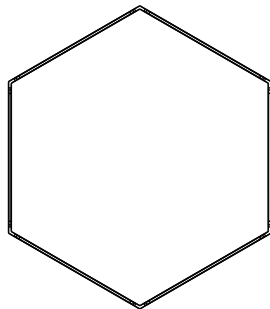

16-H: 31.5"
24-H: 45.34"

16-H: 35.7"
24-H: 51.68"

Canopy

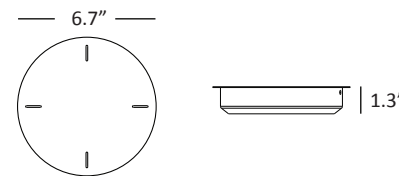

Remote Transformer

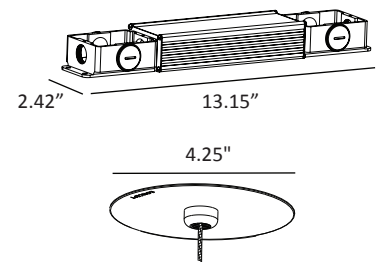

LEED information

Integrative Process

To support high-performance, cost-effective project outcomes through an early analysis of the interrelationships among systems.

Koncept's LED lighting fixtures operate at high efficacy, therefore helping to minimize energy costs. All Koncept lighting fixtures are dimmable so that occupants can choose the appropriate setting to avoid energy overuse.

Interior Lighting

To promote occupants' productivity, comfort and well-being by providing high-quality lighting.

Koncept's entire line of hardwired lighting fixtures are dimmable. Users can adjust the brightness settings to suit their needs. Furthermore, all products utilize high quality LED light sources with CRI over 80 and L90 rated lifespan over 60,000 hours.



On GSA schedule

Standard Configurations with Expandability



Shown here with acoustic panels (optional), multiple Z-Bar Pendant Honeycomb pieces can be combined to create a grid or hexagonal pattern

Standard Configurations with Expandability

There are many possible custom configurations based on pre-configured designs. Below are samples of what can be specified. For fully custom configurations, please see the Custom Configurations section.

H2

H2 consists of two honeycombs, with one shared light bar.

Lumens: 16-H2: 4400 / 24-H2: 6600 / 36-H2: 9900 /
48-H2: 14400
Energy Consumption: 16-H2: 77 W / 24-H2: 110 W / 36-H2: 165 W /
48-H2: 220 W

Order Example: [ZBP-36-H2-SW-MTB-RTM](#)

H3A

The H3A consists of three honeycombs with two shared light bars.

Lumens: 16-H3A: 6000 / 24-H3A: 9000 / 36-H3A: 13500 /
48-H3A: 18000
Energy Consumption: 16-H3A: 105 W / 24-H3A: 150 W / 36-H3A: 225 W /
48-H3A: 300 W

Order Example: [ZBP-24-H3A-SW-GLD-RTM](#)

H3B

The H3B consists of three honeycombs with two shared light bars.

Lumens: 16-H3B: 6400 / 24-H3B: 9600 / 36-H3B: 14400 /
48-H3B: 28800
Energy Consumption: 16-H3B: 112 W / 24-H3B: 160 W / 36-H3B: 240 W /
48-H3B: 320 W

Order Example: [ZBP-48-H3B-SW-MTB-CNP](#)

Dimensions

16-H2: **71.4"**
24-H2: **103.36"**
36-H2: **155"**
48-H2: **206.72"**

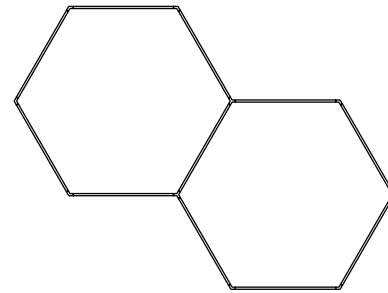

16-H2: **53.55"**
24-H2: **68"**
36-H2: **102"**
48-H2: **136"**

16-H3A: **71.4"**
24-H3A: **103.36"**
36-H3A: **155"**
48-H3A: **206.72"**

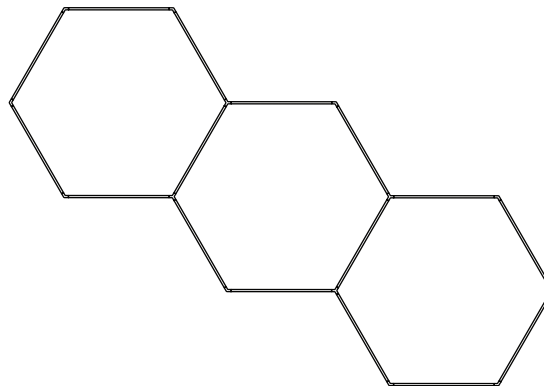

16-H3A: **63"**
24-H3A: **90.68"**
36-H3A: **136"**
48-H3A: **181.36"**

16-H3B: **107.1"**
24-H3B: **310"**
36-H3B: **465"**
48-H3B: **620.16"**

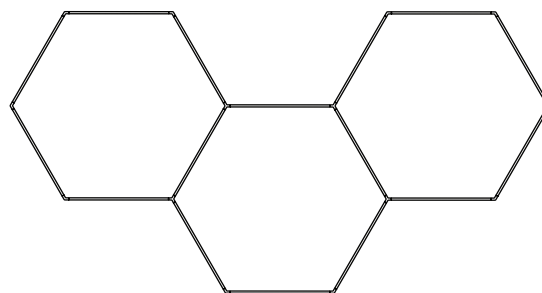

16-H3B: **53.55"**
24-H3B: **68"**
36-H3B: **102"**
48-H3B: **136"**

Standard Configurations with Expandability

H3C

The H3C consists of three honeycombs, with three shared light bars.

Lumens: 16-H3C: 6400 / 24-H3C: 9600 / 36-H3C: 14400 / 48-H3C: 28800
 Energy Consumption: 16-H3C: 112 W / 24-H3C: 160 W / 36-H3C: 240 W / 48-H3C: 320 W

Order Example: [ZBP-24-H3C-SW-GLD-RTM](#)

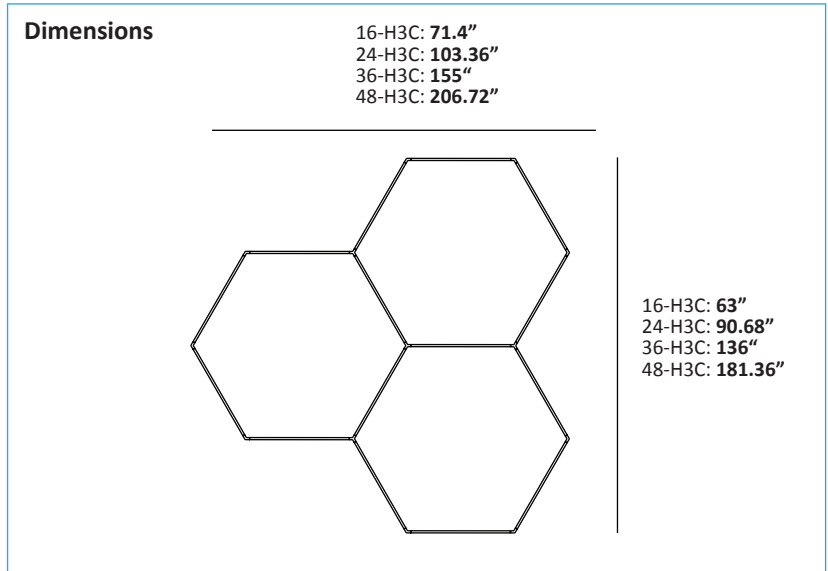

How to specify

1. Utilize the free online configurator at koncept.com/speconline.
2. Choose an option from each column on the chart below and enter into the appropriate fields at the bottom.
3. Submit this "SKU" to sales@koncept.com, along with any questions.

ZBP	Light Bar Length (in) (this is length of each light bar, NOT length of fixture.)	Model	Light Temperature (K)	Finish	Mount
	16	H2	2,700*	Silver (SIL)	Remote Transformer (RTM)
	24	H3A	3,000 (SW)	Matte Black (MTB)	
	36*	H3B	3,500*	Gold (GLD)	
	48*	H3C	4,000*	Matte White (MWT)*	
			4,500*		
			5,000*		

Order example: [ZBP](#) - [36](#) - [H3B](#) - [SW](#) - [GLD](#) - [RTM](#)

*Custom

Remote Transformer is recommended for any configuration requiring more than 40 W energy consumption. Additional lead time/charges may be applied to non-stocked options

LEED information

Integrative Process

To support high-performance, cost-effective project outcomes through an early analysis of the interrelationships among systems.

Koncept's LED lighting fixtures operate at high efficacy, therefore helping to minimize energy costs. All Koncept lighting fixtures are dimmable so that occupants can choose the appropriate setting to avoid energy overuse.

Interior Lighting

To promote occupants' productivity, comfort and well-being by providing high-quality lighting.

Koncept's entire line of hardwired lighting fixtures are dimmable. Users can adjust the brightness settings to suit their needs. Furthermore, all products utilize high quality LED light sources with CRI over 80 and L70 rated lifespan over 60,000 hours.



On GSA schedule

KONCEPT



Z-Bar pendant *square*

Standard Configuration with Expandability

The Z-Bar pendant square is a seemingly simple pendant, but boasts limitless design opportunities. Available in two standard sizes and three standard finishes, it can be enjoyed as a stand-alone configuration, or can be “expanded” into custom arrangements. Utilize Koncept’s dedicated web application to join multiple squares together to form a grid network or other unique design. This distinctive pendant is compatible with Koncept’s line of horizontal and vertical acoustic panels.

Standard Configurations



square with 16" light bars

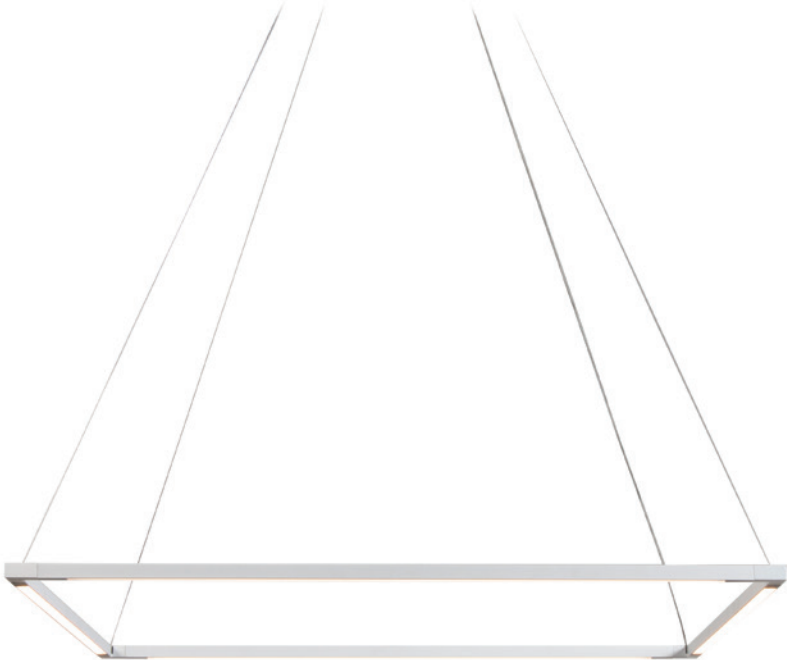

square with 24" light bars

Standard Configurations

Lumens:	16-S: 1600 / 24-S: 2400
Energy Consumption:	16-S: 28 W / 24-S: 40 W
Rated Lifespan	>60,000 hours
Color Rendering Index (CRI) :	90
Brightness Adjustability:	For CNP Option : Compatible with ELV wall dimmers For RTM Option : 1 – 10V dimming control only
Material:	Aluminum, plastic
Cable length:	10'
Safety Rating:	C-UL-US Certified, CE
Warranty:	5 years; 1 year for hardwire driver
Voltage:	120 V (Custom 277V option available, ask for details)
Standard Finishes:	Matte black, matte white, silver

Visit koncept.com/dimmers for information on compatible dimmers.
Remote transformers are only compatible with 1-10V dimmers.
Custom installations using multiple pendants will utilize a remote transformer as opposed to a canopy mount.

Power placement

There are two ways to mount the Z-Bar pendant square using the canopy: monopoint installation or multipoint installation.

Remote transformers are sold separately and are only available for multipoint installation.

Monopoint installation

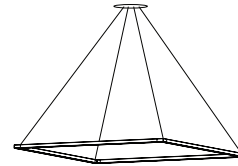

Multipoint installation

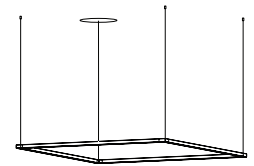

How to specify

1. Choose an option from each column and enter into the appropriate fields at the bottom.
2. Submit this "SKU" to sales@koncept.com, along with any questions.

ZBP	Light Bar Length (in) (this is length of each light bar, NOT length of fixture.)	Model	Light Temperature (K)	Finish	Mount
	16	S	2,700*	Silver (SIL)	Canopy (CNP)**
	24		3,000 (SW)	Matte Black (MTB)	Remote Transformer (RTM)**
	36*		3,500*	Matte White (MWT)	
	48*		4,000*	Gold (GLD)*	
			4,500*		
			5,000*		

Order example: **ZBP** - **24** - **S** - **SW** - **SIL** - **RTM**

*Custom

**Remote Transformer is recommended for any configuration requiring more than 40 W energy consumption.
Additional lead time/charges may be applied to non-stocked options

Dimensions

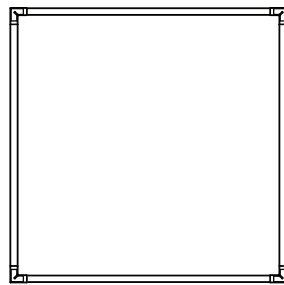

16-S: 17.98"
24-S: 25.98"

Canopy

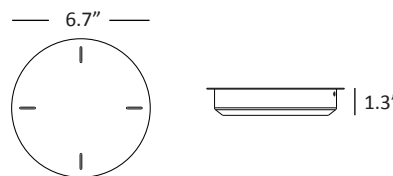

Remote Transformer

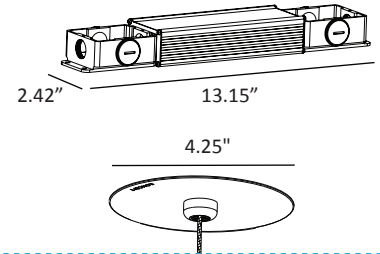

LEED information

Integrative Process

To support high-performance, cost-effective project outcomes through an early analysis of the interrelationships among systems.

Koncept's LED lighting fixtures operate at high efficacy, therefore helping to minimize energy costs. All Koncept lighting fixtures are dimmable so that occupants can choose the appropriate setting to avoid energy overuse.

Interior Lighting

To promote occupants' productivity, comfort and well-being by providing high-quality lighting.

Koncept's entire line of hardwired lighting fixtures are dimmable. Users can adjust the brightness settings to suit their needs. Furthermore, all products utilize high quality LED light sources with CRI over 80 and L90 rated lifespan over 60,000 hours.



On GSA schedule

Standard Configurations with Expandability



Z-Bar Pendant Square custom configuration with horizontal acoustic panels

Standard Configurations with Expandability

There are many possible custom configurations based on pre-configured designs. Below are samples of what can be specified. For fully custom configurations, please see the Custom Configurations section.

S2

The S2 consists of two squares with one shared joint.

Lumens: 16-S2: 3200 / 24-S2: 4800 / 36-S2: 7200 / 48-S2: 9600
 Energy Consumption: 16-S2: 56 W / 24-S2: 80 W / 36-S2: 120 W / 48-S2: 160 W

Order Example: **ZBP-16-S2-SW-SIL-CNP**

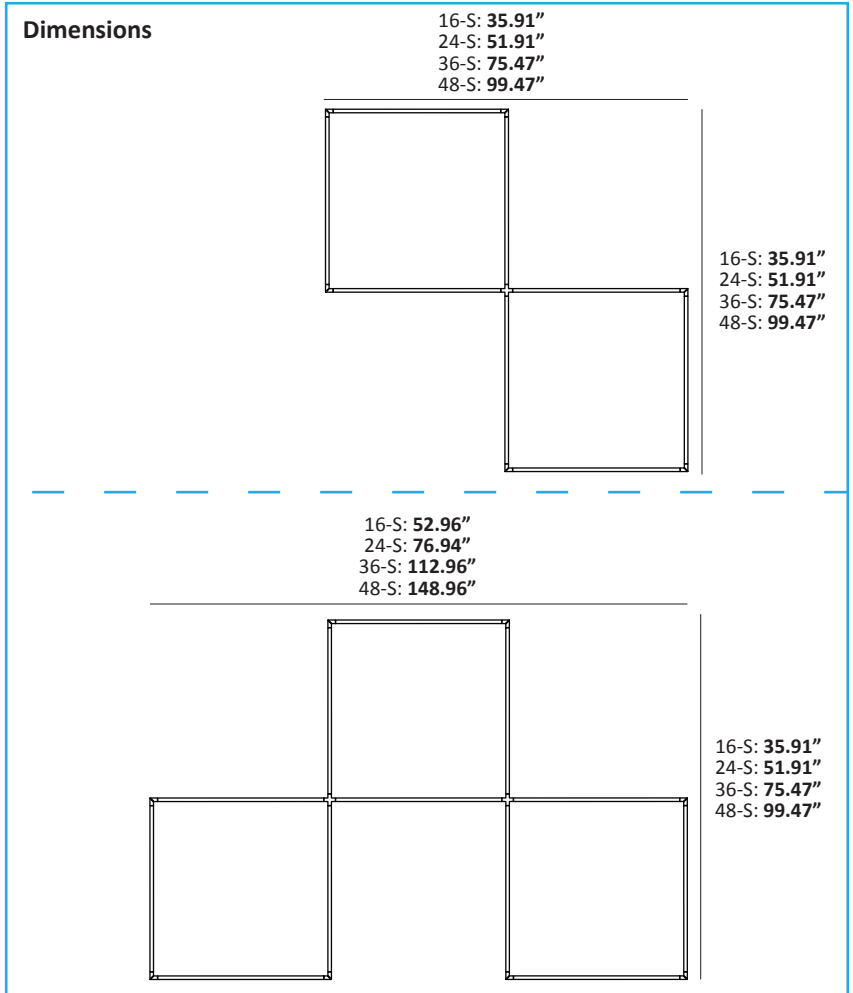

S3

The S3 consists of three squares with two shared joints.

Lumens: 16-S3: 4800 / 24-S3: 5100 / 36-S3: 7650 / 48-S3: 10200
 Energy Consumption: 16-S3: 84 W / 24-S3: 120 W / 36-S3: 180 W / 48-S3: 240 W

Order Example: **ZBP-24-S3-SW-GLD-CNP**

How to specify

1. Utilize the free online configurator at koncept.com/speconline.
2. Choose an option from each column and enter into the appropriate fields at the bottom.
3. Submit this "SKU" to sales@koncept.com, along with any questions.

ZBP	Light Bar Length (in) (this is length of each light bar, NOT length of fixture.)	Model	Light Temperature (K)	Finish	Mount
	16	S2	2,700*	Silver (SIL)	Remote Transformer (RTM)
	24	S3	3,000 (SW)	Matte Black (MTB)	
	36*		3,500*	Gold (GLD)	
	48*		4,000*	Matte White (MWT)*	
			4,500*		
			5,000*		

Order example: **ZBP - 48 - S3 - SW - GLD - RTM**

*Custom

Remote Transformer is recommended for any configuration requiring more than 40 W energy consumption. Additional lead time/charges may be applied to non-stocked options

LEED information

Integrative Process

To support high-performance, cost-effective project outcomes through an early analysis of the interrelationships among systems.

Koncept's LED lighting fixtures operate at high efficacy, therefore helping to minimize energy costs. All Koncept lighting fixtures are dimmable so that occupants can choose the appropriate setting to avoid energy overuse.

Interior Lighting

To promote occupants' productivity, comfort and well-being by providing high-quality lighting.

Koncept's entire line of hardwired lighting fixtures are dimmable. Users can adjust the brightness settings to suit their needs. Furthermore, all products utilize high quality LED light sources with CRI over 80 and L90 rated lifespan over 60,000 hours.



On GSA schedule



Z-Bar *pendant zig zag*

Standard Configuration with Expandability

Introduce a retro element to your space with the Z-Bar pendant zig zag. Available in 3 standard finishes and 2 standard sizes, the zig zag brings interest to a space and draws eyes up. Utilize Koncept's dedicated web application to join multiple zig zags together or combine with other Z-Bar pendant shapes.

Standard Configurations



zig zag with 16" light bars



zig zag with 24" light bars

Standard Configurations

Lumens:	16-ZZ: 1200 / 24-ZZ: 1800
Energy Consumption:	16-ZZ: 21 W / 24-ZZ: 30 W
Rated Lifespan	>60,000 hours
Color Rendering Index (CRI) :	90
Brightness Adjustability:	For CNP Option : Compatible with ELV wall dimmers For RTM Option : 1 – 10V dimming control only
Material:	Aluminum, plastic
Cable length:	10'
Safety Rating:	C-UL-US Certified, CE
Warranty:	5 years; 1 year for hardwire driver
Voltage:	277V (remote transformer)
Standard Finishes:	Matte black, silver, gold

*Visit koncept.com/dimmers for information on compatible dimmers. Remote transformers are only compatible with 1-10V dimmers.

Power placement

The Z-Bar pendant zig zag can only be mounted by multipoint installation.

Remote transformers are sold separately and are only available for multipoint installation.

Dimensions

Canopy

Remote Transformer

How to specify

1. Choose an option from each column and enter into the appropriate fields at the bottom.
2. Submit this "SKU" to sales@koncept.com, along with any questions.

ZBP	Light Bar Length (in) (this is length of each light bar, NOT length of fixture.)	Model	Light Temperature (K)	Finish	Mount
	16	ZZ	2,700*	Silver (SIL)	Canopy (CNP)**
	24		3,000 (SW)	Matte Black (MTB)	Remote Transformer (RTM)**
	36*		3,500*	Gold (GLD)	
	48*		4,000*	Matte White (MWT)*	
			4,500*		
			5,000*		

Order example: ZBP - 24 - ZZ - SW - SIL - CNP

*Custom

**Remote Transformer is recommended for any configuration requiring more than 40 W energy consumption. Additional lead time/charges may be applied to non-stocked options

LEED information

Integrative Process

To support high-performance, cost-effective project outcomes through an early analysis of the interrelationships among systems. Konzept's LED lighting fixtures operate at high efficacy, therefore helping to minimize energy costs. All Konzept lighting fixtures are dimmable so that occupants can choose the appropriate setting to avoid energy overuse.

Interior Lighting

To promote occupants' productivity, comfort and well-being by providing high-quality lighting.

Koncept's entire line of hardwired lighting fixtures are dimmable. Users can adjust the brightness settings to suit their needs. Furthermore, all products utilize high quality LED light sources with CRI over 80 and L90 rated lifespan over 60,000 hours.



On GSA schedule

Standard Configurations with Expandability

There are many possible custom configurations based on pre-configured designs. Below are samples of what can be specified. For fully custom configurations, please see the Custom Configurations section.

ZZ2

The ZZ2 consists of four light bars joined together to create a zig zag shape.

Lumens: 16-ZZ2: 1600 / 24-ZZ2: 2400 / 36-ZZ2: 3600 / 48-ZZ2: 4800
 Energy Consumption: 16-ZZ2: 28 W / 24-ZZ2: 40 W / 36-ZZ2: 60 W / 48-ZZ2: 80 W

Order Example: [ZBP-24-ZZ2-SW-SIL-RTM](#)

Dimensions

16-ZZ2: **61.2"**
 24-ZZ2: **88.84"**
 36-ZZ2: **132.74"**
 48-ZZ2: **177.68"**



ZZ3

The ZZ3 consists of five light bars joined together to create a zig zag shape.

Lumens: 16-ZZ3: 2000 / 24-ZZ3: 3000 / 36-ZZ3: 4500 / 48-ZZ3: 6000
 Energy Consumption: 16-ZZ3: 35 W / 24-ZZ3: 50 W / 36-ZZ3: 75 W / 48-ZZ3: 100 W

Order Example: [ZBP-16-ZZ3-SW-GLD-RTM](#)

16-ZZ3: **76.5"**
 24-ZZ3: **111.05"**
 36-ZZ3: **165.75"**
 48-ZZ3: **221.48"**

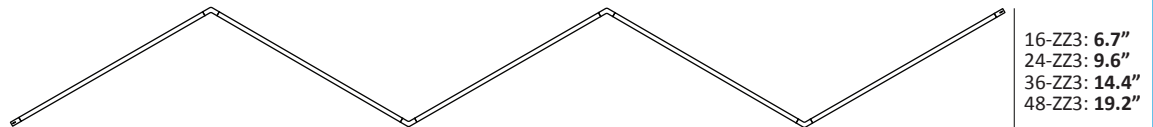

How to specify

1. Utilize the free online configurator at koncept.com/speconline.
2. Choose an option from each column and enter into the appropriate fields at the bottom.
3. Submit this "SKU" to sales@koncept.com, along with any questions.

	Light Bar Length (in) (this is length of each light bar, NOT length of fixture.)	Model	Light Temperature (K)	Finish	Mount
ZBP	16 24 36* 48*	ZZ2 ZZ3	2,700* 3,000 (SW) 3,500* 4,000* 4,500* 5,000*	Silver (SIL) Matte Black (MTB) Gold (GLD) Matte White (MWT)*	Remote Transformer (RTM)

Order example: [ZBP](#) - [16](#) - [ZZ3](#) - [SW](#) - [MTB](#) - [RTM](#)

*Custom

Remote Transformer is recommended for any configuration requiring more than 40 W energy consumption. Additional lead time/charges may be applied to non-stocked options

LEED information

Integrative Process

To support high-performance, cost-effective project outcomes through an early analysis of the interrelationships among systems.

Koncept's LED lighting fixtures operate at high efficacy, therefore helping to minimize energy costs. All Koncept lighting fixtures are dimmable so that occupants can choose the appropriate setting to avoid energy overuse.

Interior Lighting

To promote occupants' productivity, comfort and well-being by providing high-quality lighting.

Koncept's entire line of hardwired lighting fixtures are dimmable. Users can adjust the brightness settings to suit their needs. Furthermore, all products utilize high quality LED light sources with CRI over 80 and L90 rated lifespan over 60,000 hours.



On GSA schedule



Z-Bar pendant *trio*

Standard Configuration with Expandability

The Z-Bar pendant trio utilizes a “Y” joint to create an minimalist geometric shape. Available in 3 standard finishes and 2 standard sizes, it is compatible with Koncept’s vertical acoustic panels. Utilize Koncept’s dedicated web application to join multiple trios together or combine with other Z-Bar Pendants.

Standard Configurations



trio with 16" light bars

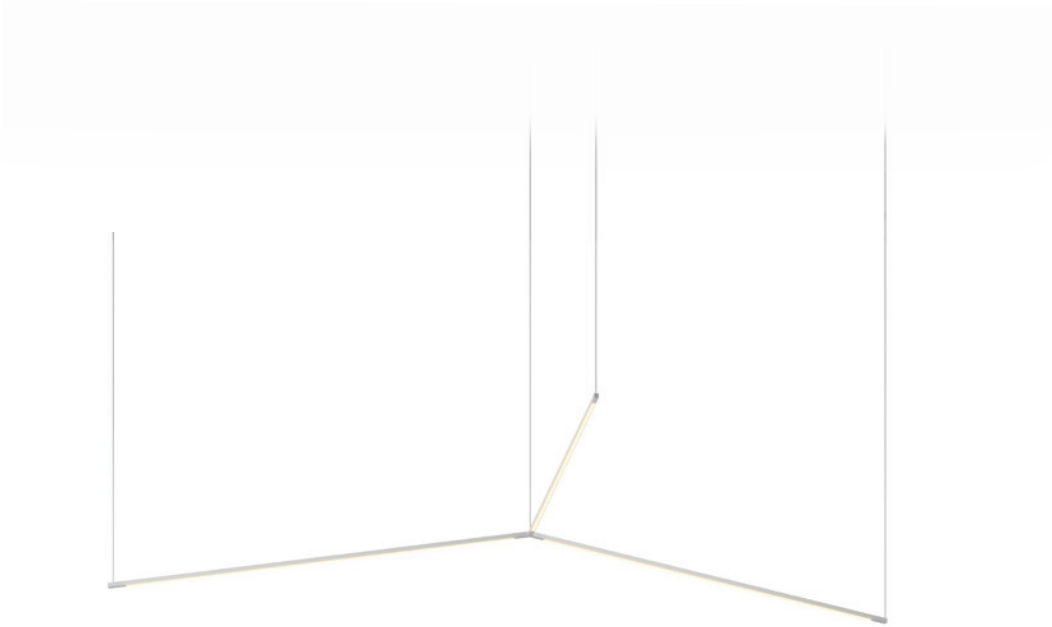

trio with 24" light bars

Standard Configurations

Lumens:	16-TR: 1200 / 24-TR: 1800
Energy Consumption:	16-TR: 21 W / 24-TR: 30 W
Rated Lifespan	>60,000 hours
Color Rendering Index (CRI) :	90
Brightness Adjustability:	For CNP Option : Compatible with ELV wall dimmers For RTM Option : 1 – 10V dimming control only
Material:	Aluminum, plastic
Cable length:	10'
Safety Rating:	C-UL-US Certified, CE
Warranty:	5 years; 1 year for hardwire driver
Voltage:	120 V (Custom 277V option available, ask for details)
Standard Finishes:	Matte black, silver, gold

Visit koncept.com/dimmers for information on compatible dimmers.
Remote transformers are only compatible with 1-10V dimmers.

Dimensions

16-TR: 27.3"
24-TR: 39.3"

16-TR: 31.5"
24-TR: 45.4"

Canopy

6.7"

1.3"

Remote Transformer

2.42"

13.15"

4.25"

Power placement

There are two ways to mount the Z-Bar pendant trio using the canopy: monopoint installation or multipoint installation. The same parts are used for each installation method.

Remote transformers are sold separately and are only available for multipoint installation.

Monopoint installation

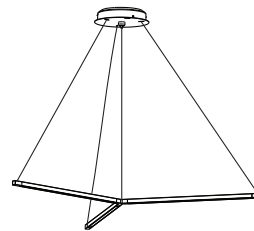

Multipoint installation

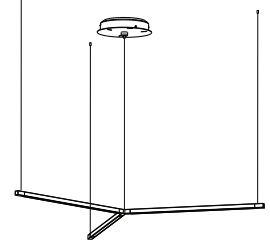

How to specify

1. Choose an option from each column and enter into the appropriate fields at the bottom.
2. Submit this "SKU" to sales@koncept.com, along with any questions.

ZBP	Light Bar Length (in) (this is length of each light bar, NOT length of fixture.)	Model	Light Temperature (K)	Finish	Mount
	16	TR	2,700*	Silver (SIL)	Canopy (CNP)*
	24		3,000 (SW)	Matte Black (MTB)	Remote Transformer (RTM)**
	36*		3,500*	Gold (GLD)	
	48*		4,000*	Matte White (MWT)*	
			4,500*		
			5,000*		

Order example: ZBP - 24 - TR - SW - SIL - CNP

*Custom

**Remote Transformer is recommended for any configuration requiring more than 40 W energy consumption
Additional lead time/charges may be applied to non-stocked options

LEED information

Integrative Process

To support high-performance, cost-effective project outcomes through an early analysis of the interrelationships among systems. Koncept's LED lighting fixtures operate at high efficacy, therefore helping to minimize energy costs. All Koncept lighting fixtures are dimmable so that occupants can choose the appropriate setting to avoid energy overuse.

Interior Lighting

To promote occupants' productivity, comfort and well-being by providing high-quality lighting.

Koncept's entire line of hardwired lighting fixtures are dimmable. Users can adjust the brightness settings to suit their needs. Furthermore, all products utilize high quality LED light sources with CRI over 80 and L90 rated lifespan over 60,000 hours.



On GSA schedule

Standard Configurations with Expandability

There are many possible custom configurations based on pre-configured designs. Below are samples of what can be specified. For fully custom configurations, please see the Custom Configurations section.

TR2

The TR2 consists of two trios merged at one point.

Lumens: 16-TR2: 2400 / 24-TR2: 3600 / 36-TR2: 5400
/ 48-TR2: 7200

Energy Consumption: 16-TR2: 42 W / 24-TR2: 60 W / 36-TR2: 90 W
/ 48-TR2: 120 W

Order Example: [ZBP-24-TR2-SW-SIL-RTM](#)

TR3

The TR3 consists of two full and one partial trios, connected at two points.

Lumens: 16-TR3: 3200 / 24-TR3: 4800 / 36-TR3: 7200
/ 48-TR3: 9600

Energy Consumption: 16-TR3: 56 W / 24-TR3: 80 W / 36-TR3: 120 W
/ 48-TR3: 160 W

Order Example: [ZBP-16-TR3-SW-GLD-RTM](#)

How to specify

- Utilize the free online configurator at koncept.com/speconline.
- Choose an option from each column and enter into the appropriate fields at the bottom.
- Submit this "SKU" to sales@koncept.com, along with any questions.

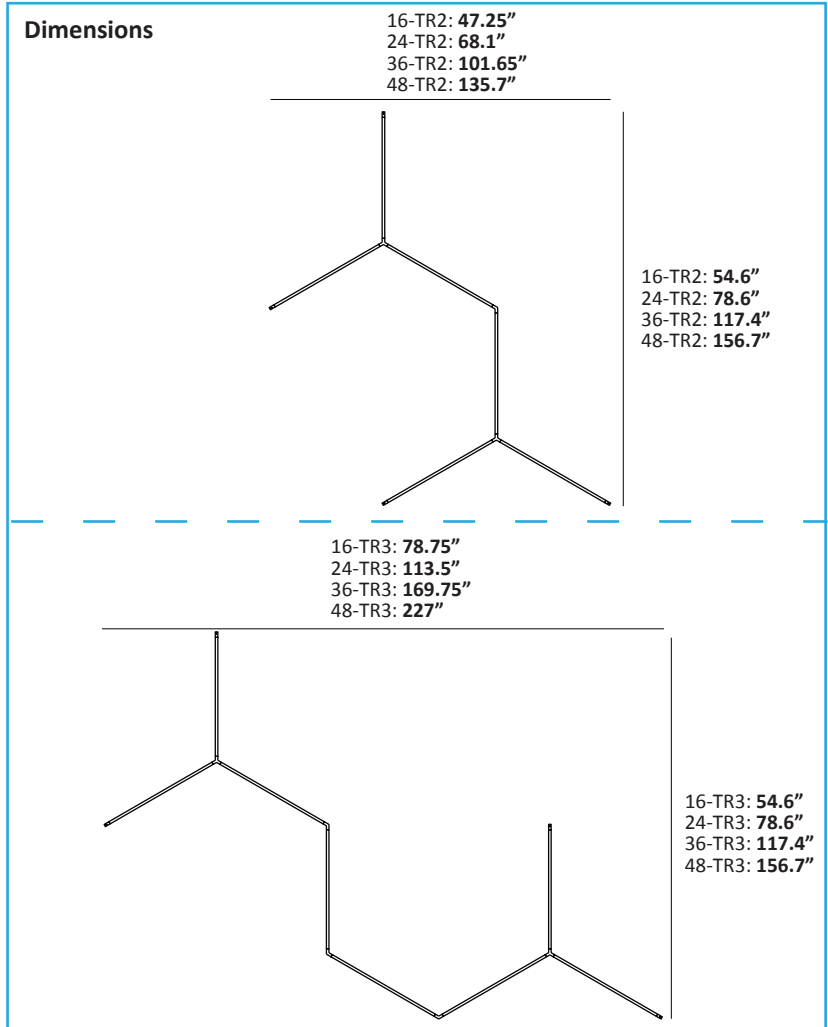

	Light Bar Length (in) (this is length of each light bar, NOT length of fixture.)	Model	Light Temperature (K)	Finish	Mount
ZBP	16 24 36* 48*	TR2 TR3	2,700* 3,000 (SW) 3,500* 4,000* 4,500* 5,000*	Silver (SIL) Matte Black (MTB) Gold (GLD) Matte White (MWT)*	Remote Transformer (RTM)

Order example: [ZBP](#) - [16](#) - [TR2](#) - [SW](#) - [MTB](#) - [RTM](#)

*Custom

Remote Transformer is recommended for any configuration requiring more than 40 W energy consumption
Additional lead time/charges may be applied to non-stocked options

LEED information

Integrative Process

To support high-performance, cost-effective project outcomes through an early analysis of the interrelationships among systems.

Koncept's LED lighting fixtures operate at high efficacy, therefore helping to minimize energy costs. All Koncept lighting fixtures are dimmable so that occupants can choose the appropriate setting to avoid energy overuse.

Interior Lighting

To promote occupants' productivity, comfort and well-being by providing high-quality lighting.

Koncept's entire line of hardwired lighting fixtures are dimmable. Users can adjust the brightness settings to suit their needs. Furthermore, all products utilize high quality LED light sources with CRI over 80 and L90 rated lifespan over 60,000 hours.



On GSA schedule



Z-Bar pendant *bird*

The renowned Z-Bar pendant bird is a unique, three-dimensional shape that invokes flight. Available in three standard finishes and four standard sizes, it brings an element of modernity to any interior.

Standard Configurations

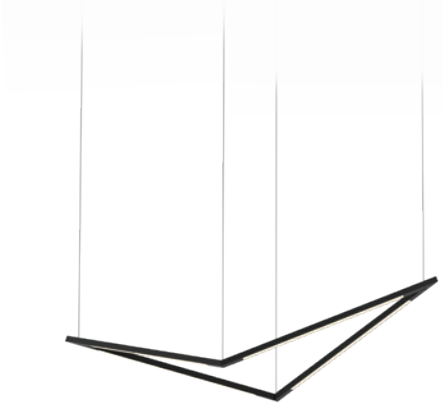

bird with 16" light bars

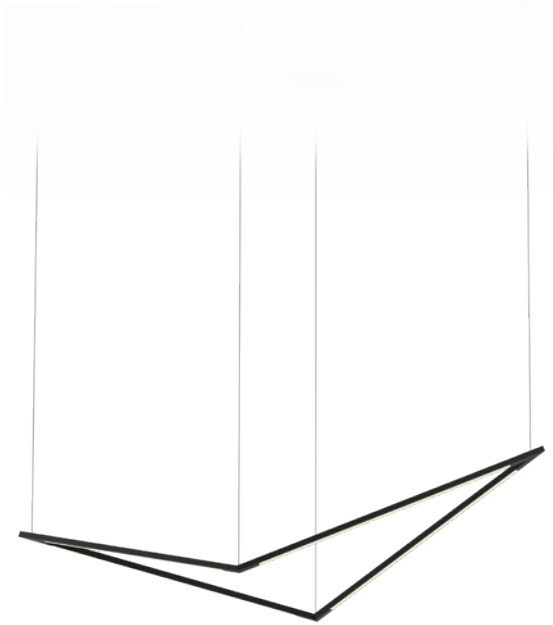

bird with 24" light bars

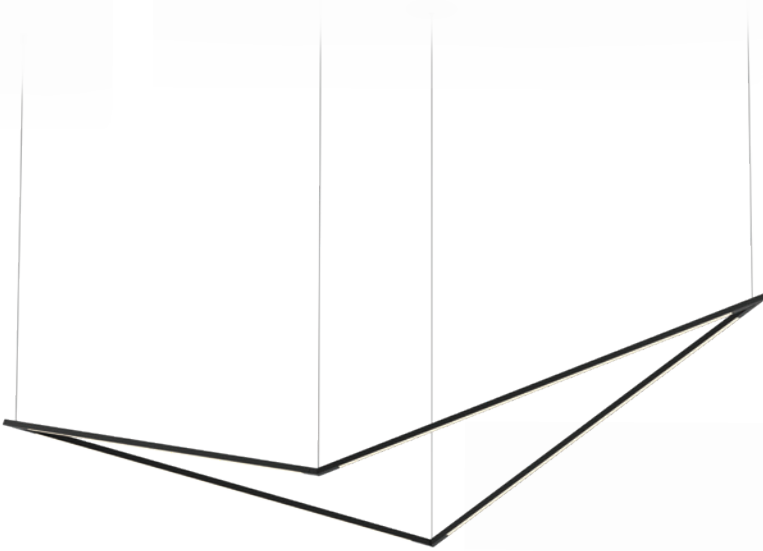

bird with 36" light bars

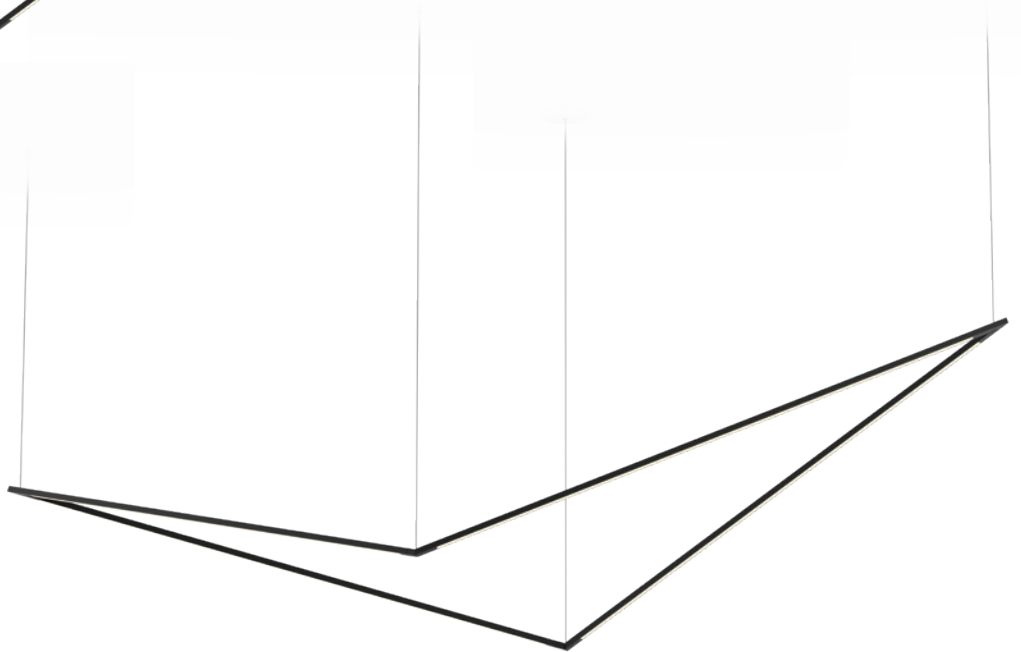

bird with 48" light bars



Standard Configurations

Lumens: 16-B: 1600 / 24-B: 2400 / 36-B: 2700 / 48-B: 5200
Energy Consumption: 16-B: 28 W / 24-B: 40 W / 36-B: 45 W / 48-B: 80 W
Rated Lifespan >60,000 hours
Color Rendering Index (CRI) : 90
Brightness Adjustability: For CNP Option : Compatible with ELV wall dimmers
 For RTM Option : 1 – 10V dimming control only
Material: Aluminum, plastic
Cable length: 10'
Safety Rating: C-UL-US Certified, CE
Warranty: 5 years; 1 year for hardwire driver
Voltage: 120 V (Custom 277V option available, ask for details)
Standard Finishes: Matte black, matte white, silver

Visit koncept.com/dimmers for information on compatible dimmers. Remote transformers are only compatible with 1-10V dimmers.

Power placement

There are two ways to mount the Z-Bar pendant bird using the canopy: monopoint installation or multipoint installation. The same parts are used for each installation method.

Remote transformers are sold separately and are only available for multipoint installation.

Monopoint installation

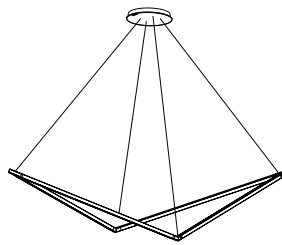

Multipoint installation

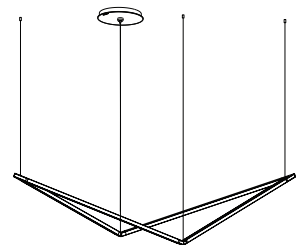

Dimensions 16-B = 10.5" 24-B = 14.68" 36-B = 22" 48-B = 29.36" 16-B = 34" 24-B = 49" 36-B = 70.5" 48-B = 92" 	16-B = 6.75" 24-B = 9.375" 36-B = 13.375" 48-B = 17.375"	Canopy 	Remote Transformer
	*Compatible with 16-B, 24-B, 36-B only		

How to specify

1. Choose an option from each column and enter into the appropriate fields at the bottom.
2. Submit this "SKU" to sales@koncept.com, along with any questions.

	Light Bar Length (in) (this is length of each light bar, NOT length of fixture.)	Model	Light Temperature (K)	Finish	Mount
ZBP	16 24 36 48	B	2,700* 3,000 (SW) 3,500* 4,000* 4,500* 5,000*	Silver (SIL) Matte Black (MTB) Matte White (MWT) Gold (GLD)	Canopy (CNP)** Remote Transformer (RTM)**

Order example: ZBP - 24 - B - SW - SIL - CNP

*Custom

**Remote Transformer is recommended for any configuration requiring more than 40 W energy consumption
Additional lead time/charges may be applied to non-stocked options

LEED information

Integrative Process

To support high-performance, cost-effective project outcomes through an early analysis of the interrelationships among systems.

Koncept's LED lighting fixtures operate at high efficacy, therefore helping to minimize energy costs. All Koncept lighting fixtures are dimmable so that occupants can choose the appropriate setting to avoid energy overuse.

Interior Lighting

To promote occupants' productivity, comfort and well-being by providing high-quality lighting.

Koncept's entire line of hardwired lighting fixtures are dimmable. Users can adjust the brightness settings to suit their needs. Furthermore, all products utilize high quality LED light sources with CRI over 80 and L90 rated lifespan over 60,000 hours.



On GSA schedule



Z-Bar pendant *rectangle*

Standard Configuration with Expandability

The Z-Bar pendant rectangle is available in two standard sizes and can be used in countless settings. Perfect for a minimalist approach to lighting a dining room table, adds a modern touch to a basement bar, contributes sophistication to a hall or entry way. In three standard finishes, it can be enjoyed as a stand-alone configuration, or can be “expanded” into custom arrangements. Utilize Koncept’s dedicated web application to join multiple rectangles together or combine with other Z-Bar Pendants. This timeless pendant is compatible with Koncept’s line of horizontal and vertical acoustic panels.

Standard Configurations



Rectangle (with 36" light bars)

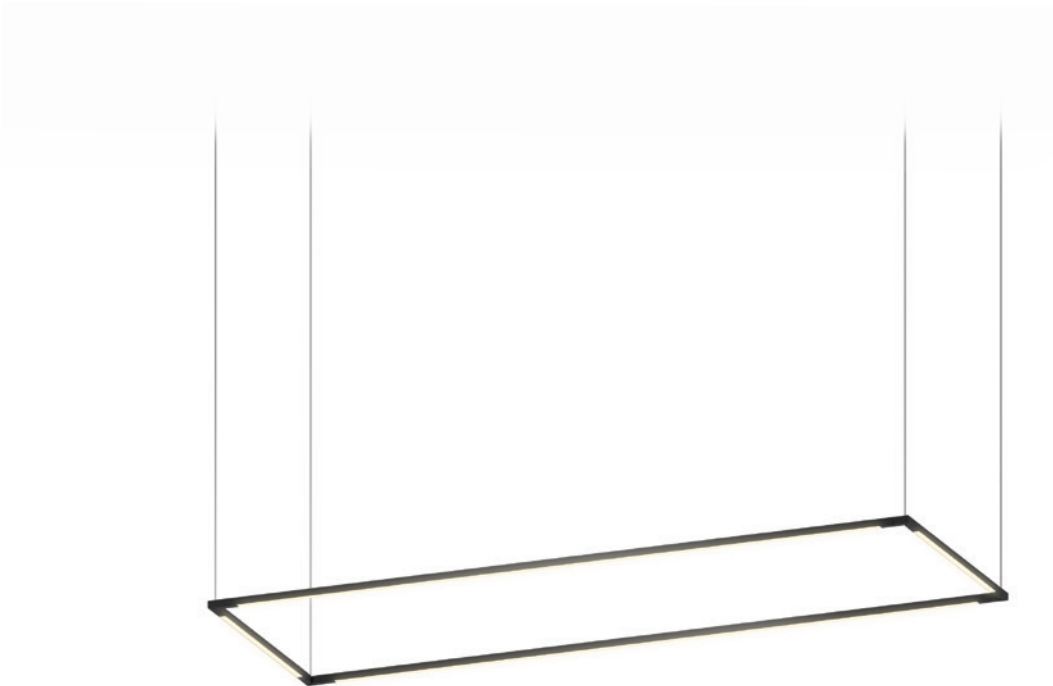

Rectangle (with 48" light bars)

Standard Configurations

Lumens: 36-R: 2400 / 48-R: 3300
Energy Consumption: 36-R: 45 W / 48-R: 55 W
Rated Lifespan >60,000 hours
Color Rendering Index (CRI) : 90
Brightness Adjustability: For CNP Option : Compatible with ELV wall dimmers
 For RTM Option : 1 – 10V dimming control only
Material: Aluminum, plastic
Cable length: 10'
Safety Rating: C-UL-US Certified, CE
Warranty: 5 years; 1 year for hardwire driver
Voltage: 120 V (Custom 277V option available, ask for details)
Standard Finishes: Matte black, matte white, silver

Visit koncept.com/dimmers for information on compatible dimmers.
 Remote transformers are only compatible with 1-10V dimmers.
 Custom installations using multiple pendants will utilize a remote transformer as opposed to a canopy mount.

Power placement

There are two ways to mount the Z-Bar pendant Rectangle using the canopy: monopoint installation or multipoint installation.

Remote transformers are sold separately and are only available for multipoint installation.

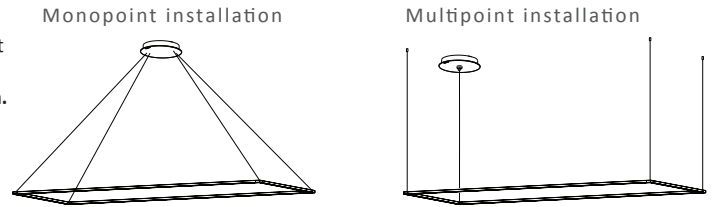

How to specify

1. Choose an option from each column and enter into the appropriate fields at the bottom.
2. Submit this "SKU" to sales@koncept.com, along with any questions.

ZBP	Light Bar Length (in) (this is length of each light bar, NOT length of fixture.)	Model	Light Temperature (K)	Finish	Mount
	36	R	2,700*	Silver (SIL)	Canopy (CNP)**
	48		3,000 (SW)	Matte Black (MTB)	Remote Transformer (RTM)**
			3,500*	Gold (GLD)	
			4,000*		
			4,500*		
			5,000*		

Order example: ZBP - 16 - R - SW - SIL - RTM

*Custom

**Remote Transformer is recommended for any configuration requiring more than 40 W energy consumption.
 Additional lead time/charges may be applied to non-stocked options

Dimensions

36-R: 14.1"
48-R: 18.2"

36-R: 38.4"
48-R: 50.5"

Canopy

6.7"

1.3"

Remote Transformer

2.42"

13.15"

4.25"

LEED information

Integrative Process

To support high-performance, cost-effective project outcomes through an early analysis of the interrelationships among systems.

Koncept's LED lighting fixtures operate at high efficacy, therefore helping to minimize energy costs. All Koncept lighting fixtures are dimmable so that occupants can choose the appropriate setting to avoid energy overuse.

Interior Lighting

To promote occupants' productivity, comfort and well-being by providing high-quality lighting.

Koncept's entire line of hardwired lighting fixtures are dimmable. Users can adjust the brightness settings to suit their needs. Furthermore, all products utilize high quality LED light sources with CRI over 80 and L90 rated lifespan over 60,000 hours.



On GSA schedule

Standard Configurations with Expandability



Z-Bar pendant rectangle custom configuration

Standard Configurations with Expandability

There are many possible custom configurations based on pre-configured designs. Below are samples of what can be specified. For fully custom configurations, please see the Custom Configurations section.

R2

The R2 consists of two rectangles with one shared light bar.

Lumens: 36-R2: 1500 / 48-R2: 2000
Energy Consumption: 36-R2: 59 W / 48-R2: 81 W

Order Example: **ZBP-36-R2-SW-MTB-RTM**

Dimensions

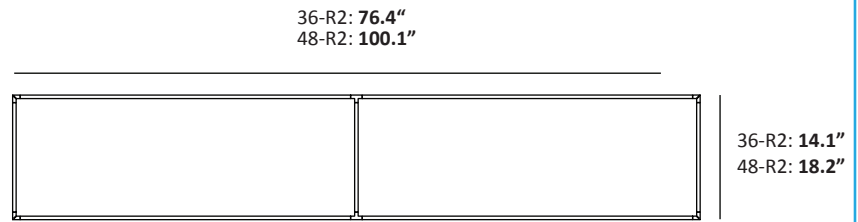

R2B

The R2B consists of one rectangle and one square, with one shared joint.

Lumens: 36-R2B: 3900 / 48-R2B: 5100
Energy Consumption: 36-R2B: 66 W / 48-R2B: 85 W

Order Example: **ZBP-48-R2B-SW-SIL-RTM**

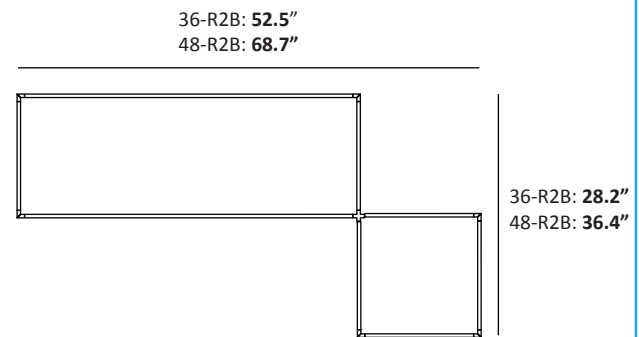

How to specify

1. Utilize the free online configurator at koncept.com/speconline.
2. Choose an option from each column and enter into the appropriate fields at the bottom.
3. Submit this "SKU" to sales@koncept.com, along with any questions.

	Light Bar Length (in) (this is length of each light bar, NOT length of fixture.)	Model	Light Temperature (K)	Finish	Mount
ZBP	16*	R2	2,700*	Silver (SIL)	Remote Transformer (RTM)
	24*	R2B	3,000 (SW)	Matte Black (MTB)	
	36		3,500*	Gold (GLD)	
	48		4,000*	Matte White (MWT)*	
			4,500*		
			5,000*		

Order example: **ZBP - 48 - R2 - SW - GLD - RTM**

*Custom

Remote Transformer is recommended for any configuration requiring more than 40 W energy consumption
Additional lead time/charges may be applied to non-stocked options

LEED information

Integrative Process

To support high-performance, cost-effective project outcomes through an early analysis of the interrelationships among systems.

Koncept's LED lighting fixtures operate at high efficacy, therefore helping to minimize energy costs. All Koncept lighting fixtures are dimmable so that occupants can choose the appropriate setting to avoid energy overuse.

Interior Lighting

To promote occupants' productivity, comfort and well-being by providing high-quality lighting.

Koncept's entire line of hardwired lighting fixtures are dimmable. Users can adjust the brightness settings to suit their needs. Furthermore, all products utilize high quality LED light sources with CRI over 80 and L90 rated lifespan over 60,000 hours.



On GSA schedule



Z-Bar pendant *linear*

Standard Configuration with Expandability

The Z-Bar Pendant is stripped down to its most basic form: linear. Available in three standard finishes and four standard sizes, it brings an element of modernity to any interior. Utilize Koncept's dedicated web application to join multiple linear pendant together or combine with other Z-Bar Pendants.

Standard Configurations



linear with 36" light bars



linear with 48" light bars

Standard Configurations

Lumens:	36-L: 900 / 48-L: 1200
Energy Consumption:	36-L: 15 W / 48-L: 20 W
Rated Lifespan	>60,000 hours
Color Rendering Index (CRI) :	90
Brightness Adjustability:	For CNP Option : Compatible with ELV wall dimmers For RTM Option : 1 – 10V dimming control only
Material:	Aluminum, plastic
Cable length:	10'
Safety Rating:	C-UL-US Certified, CE
Warranty:	5 years; 1 year for hardwire driver
Voltage:	120 V (Custom 277V option available, ask for details)
Standard Finishes:	Matte black, gold, silver

Visit koncept.com/dimmers for information on compatible dimmers.
Remote transformers are only compatible with 1-10V dimmers. Custom installations using multiple pendants will utilize a remote transformer as opposed to a canopy mount.

Power placement

The Z-Bar pendant linear can only be mounted by multipoint installation.

Remote transformers are sold separately and are only available for multipoint installation.

How to specify

1. Choose an option from each column and enter into the appropriate fields at the bottom.
2. Submit this "SKU" to sales@koncept.com, along with any questions.

Multipoint installation

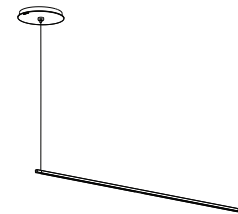

ZBP	Light Bar Length (in) (this is length of each light bar, NOT length of fixture.)	Model	Light Temperature (K)	Finish	Mount
	36	L	2,700*	Silver (SIL)	Canopy (CNP)
	48		3,000 (SW)	Matte Black (MTB)	Remote Transformer (RTM)
	72		3,500*	Gold (GLD)	
	96		4,000*	Matte White (MWT)*	
			4,500*		
			5,000*		

Order example: ZBP - 36 - L - SW - SIL - CNP

*Custom
Additional lead time/charges may be applied to non-stocked options

Dimensions

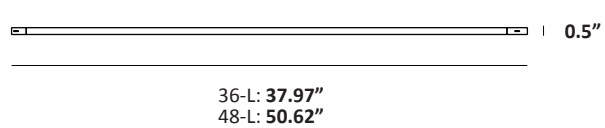

Canopy

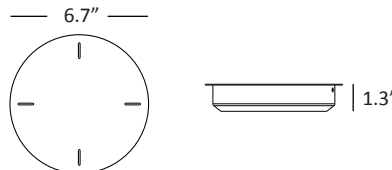

Remote Transformer

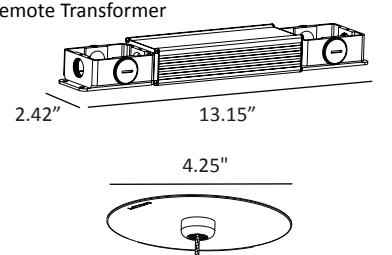

LEED information

Integrative Process

To support high-performance, cost-effective project outcomes through an early analysis of the interrelationships among systems.

Koncept's LED lighting fixtures operate at high efficacy, therefore helping to minimize energy costs. All Koncept lighting fixtures are dimmable so that occupants can choose the appropriate setting to avoid energy overuse.

Interior Lighting

To promote occupants' productivity, comfort and well-being by providing high-quality lighting.

Koncept's entire line of hardwired lighting fixtures are dimmable. Users can adjust the brightness settings to suit their needs. Furthermore, all products utilize high quality LED light sources with CRI over 80 and L90 rated lifespan over 60,000 hours.



On GSA schedule

Standard Configurations with Expandability



Z-Bar Pendant Linear custom configuration

Standard Configurations with Expandability

There are many possible custom configurations based on pre-configured designs. Below are samples of what can be specified. For fully custom configurations, please see the Custom Configurations section.

L2

The L2 consists of two linears with a shared joint in the center.

Estimated Lumens: 16-L2: 800 / 24-L2: 1200 / 72-L: 1800 / 96-L: 2400
 Estimated Energy Consumption: 16-L2: 14 W / 24-L2: 20 W / 72-L: 30 W / 96-L: 40 W

Order Example: **ZBP-72-L-SW-MTB-CNP**

Dimensions

16-L2: **35.96"**
 24-L2: **51.96"**
 72-L: **75.94"**
 96-L: **101.24"**



L3

The L3 consists of three linears with two shared joints.

Lumens: 16-L3: 1200 / 24-L3: 1800 / 36-L3: 2700 / 48-L3: 3600
 Energy Consumption: 16-L3: 21 W / 24-L3: 30 W / 36-L3: 45 W / 48-L3: 60 W

Order Example: **ZBP-36-L3-SW-MTB-RTM**

Dimensions

16-L3: **53.94"**
 24-L3: **77.94"**
 36-L3: **113.91"**
 48-L3: **151.86"**

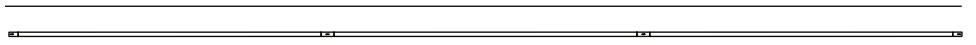

L4

The L4 consists of four linears with three shared joints.

Lumens: 16-L4: 1600 / 24-L4: 2400 / 36-L4: 2700 / 48-L4: 4800
 Energy Consumption: 16-L4: 28 W / 24-L4: 40 W / 36-L4: 60 W / 48-L4: 80 W

Order Example: **ZBP-16-L4-SW-SIL-RTM**

Dimensions

16-L4: **71.92"**
 24-L4: **103.92"**
 36-L4: **151.88"**
 48-L4: **202.48"**

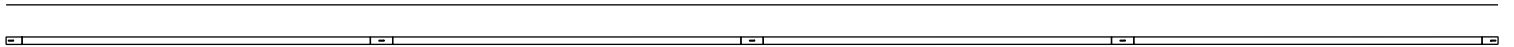

How to specify

- Utilize the free online configurator at koncept.com/speconline.
- Choose an option from each column on the chart below and enter into the appropriate fields at the bottom.
- Submit this "SKU" to sales@koncept.com, along with any questions.

	Light Bar Length (in)	Model	Light Temperature (K)	Finish	Mount
ZBP	36	L	2,700*	Silver (SIL)	CNP**
	48	L2	3,000 (SW)	Matte Black (MTB)	RTM**
	72	L3	3,500*	Gold (GLD)	
	96	L4	4,000*	Matte White (MWT)*	
				4,500*	
			5,000*		

Order example: **ZBP** - **48** - **L4** - **SW** - **MTB** - **RTM**

*Custom

**Remote Transformer is recommended for any configuration requiring more than 40 W energy consumption. Additional lead time/charges may be applied to non-stocked options

LEED information

Integrative Process

To support high-performance, cost-effective project outcomes through an early analysis of the interrelationships among systems. Koncept's LED lighting fixtures operate at high efficacy, therefore helping to minimize energy costs. All Koncept lighting fixtures are dimmable so that occupants can choose the appropriate setting to avoid energy overuse.

Interior Lighting

To promote occupants' productivity, comfort and well-being by providing high-quality lighting.

Koncept's entire line of hardwired lighting fixtures are dimmable. Users can adjust the brightness settings to suit their needs. Furthermore, all products utilize high quality LED light sources with CRI over 80 and L90 rated lifespan over 60,000 hours.



On GSA schedule



Z-Bar pendant crown

The Z-Bar pendant crown is a dramatic piece comprised of 12 LED light bars. Available in 3 standard finishes and 2 standard sizes, it's suitable for commercial and residential spaces alike.

Standard Configurations

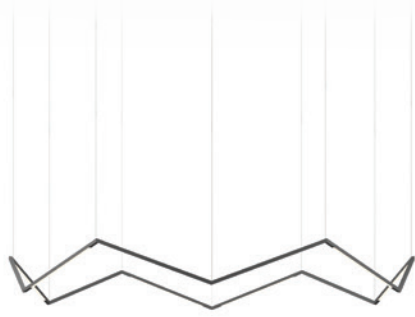

crown with 16" light bars

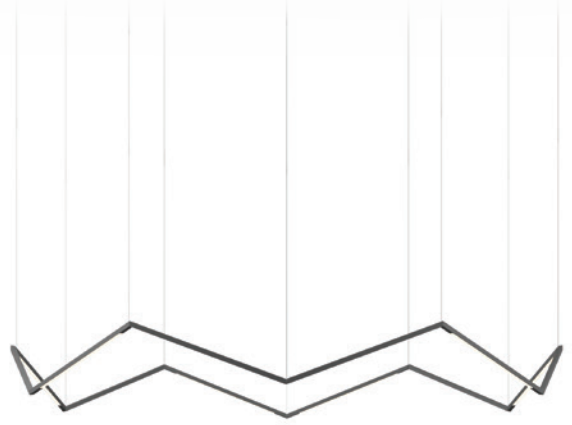

crown with 24" light bars

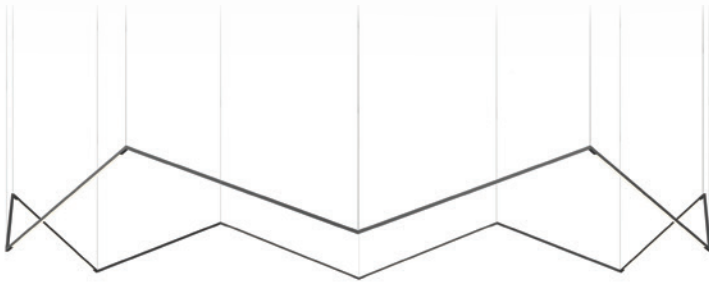

crown with 36" light bars

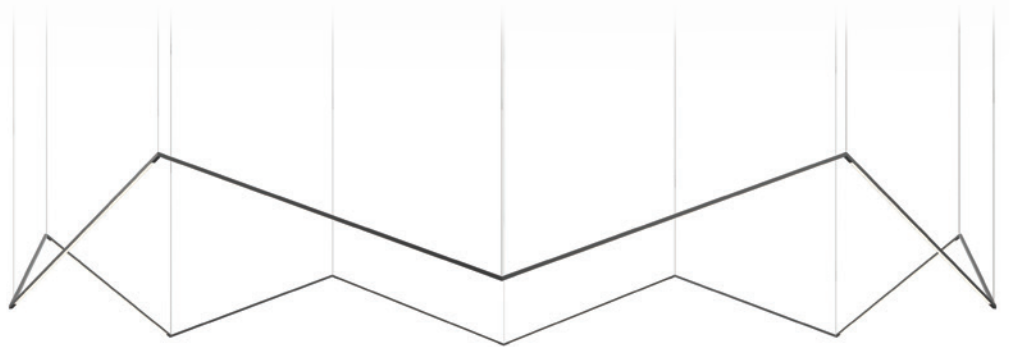

crown with 48" light bars

Standard Configurations

Lumens:	16-C: 4800 / 24-C: 7200 / 36-C: 10800 / 48-C: 14400
Energy Consumption:	16-C: 84 W / 24-C: 120 W / 36-C: 180 W / 48-C: 240 W
Rated Lifespan	>60,000 hours=
Color Rendering Index (CRI) :	90
Brightness Adjustability:	For CNP Option : Compatible with ELV wall dimmers For RTM Option : 1 – 10V dimming control only
Material:	Aluminum, plastic
Cable length:	10'
Safety Rating:	C-UL-US Certified, CE
Warranty:	5 years; 1 year for hardwire driver
Voltage:	277V (remote transformer)
Standard Finishes:	Matte black, matte white, silver

*Visit koncept.com/dimmers for information on compatible dimmers.
Remote transformers are only compatible with 1-10V dimmers.

Power placement

The Z-Bar pendant crown can only be mounted by multipoint installation.
Remote transformers are sold separately and are only available for multipoint installation.

Dimensions

16-C: **62.8"**
24-C: **91.41"**
36-C: **137.12"**
48-C: **182.82"**

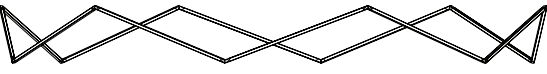

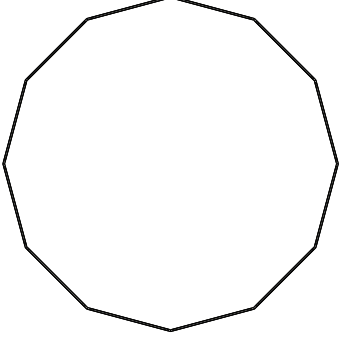

Remote Transformer

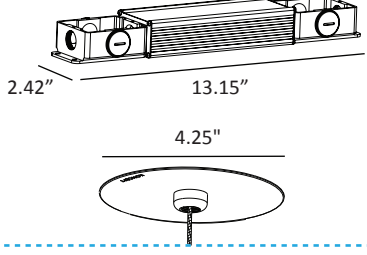

16-C: **63.8"**
24-C: **92.76"**
36-C: **139.14"**
48-C: **185.52"**

How to specify

1. Choose an option from each column and enter into the appropriate fields at the bottom.
2. Submit this "SKU" to sales@koncept.com, along with any questions.

ZBP	Light Bar Length (in) (this is length of each light bar, NOT length of fixture.)	Model	Light Temperature (K)	Finish	Mount
	16	C	2,700*	Silver (SIL)	Remote Transformer (RTM)
	24		3,000 (SW)	Matte Black (MTB)	
	36*		3,500*	Matte White (MWT)	
	48*		4,000*	Gold (GLD)*	
			4,500*		
			5,000*		

Order example: ZBP - 24 - C - SW - SIL - RTM

*Custom

Remote Transformer is recommended for any configuration requiring more than 40 W energy consumption
Additional lead time/charges may be applied to non-stocked options

LEED information

Integrative Process

To support high-performance, cost-effective project outcomes through an early analysis of the interrelationships among systems.

Koncept's LED lighting fixtures operate at high efficacy, therefore helping to minimize energy costs. All Koncept lighting fixtures are dimmable so that occupants can choose the appropriate setting to avoid energy overuse.

Interior Lighting

To promote occupants' productivity, comfort and well-being by providing high-quality lighting.

Koncept's entire line of hardwired lighting fixtures are dimmable. Users can adjust the brightness settings to suit their needs. Furthermore, all products utilize high quality LED light sources with CRI over 80 and L90 rated lifespan over 60,000 hours.



On GSA schedule

koncept



Z-Bar pendant *tri-star*

The Z-Bar Pendant tri-star is a striking configuration of six LED light bars. Available in three standard finishes and two standard sizes, it brings light, modernity and a sense of drama to any interior.

Standard Configurations



tri-star with 36" light bars



tri-star with 48" light bars

Standard Configurations

Lumens:	36-TS: 5400 / 48-TS: 7800
Energy Consumption:	36-TS: 90 W / 48-TS: 120 W
Rated Lifespan	>60,000 hours
Color Rendering Index (CRI) :	90
Brightness Adjustability:	For CNP Option : Compatible with ELV wall dimmers For RTM Option : 1 – 10V dimming control only
Material:	Aluminum, plastic
Cable length:	10'
Safety Rating:	C-UL-US Certified, CE
Warranty:	5 years; 1 year for hardwire driver
Voltage:	277V (remote transformer)
Standard Finishes:	Matte black, gold, silver

*Visit koncept.com/dimmers for information on compatible dimmers.
Remote transformers are only compatible with 1-10V dimmers.

Power placement

The Z-Bar pendant tri-star can only be mounted by multipoint installation.
Remote transformers are sold separately and are only available for multipoint installation.

How to specify

1. Choose an option from each column and enter into the appropriate fields at the bottom.
2. Submit this "SKU" to sales@koncept.com, along with any questions.

ZBP	Light Bar Length (in) (this is length of each light bar, NOT length of fixture.)	Model	Light Temperature (K)	Finish	Mount
	16*	TS	2,700*	Silver (SIL)	Remote Transformer (RTM)
	24*		3,000 (SW)	Matte Black (MTB)	
	36		3,500*	Gold (GLD)	
	48		4,000*	Matte White (MWT)*	
			4,500*		
			5,000*		

Order example: ZBP - 36 - TS - SW - SIL - RTM

*Custom
Remote Transformer is recommended for any configuration requiring more than 40 W energy consumption
Additional lead time/charges may be applied to non-stocked options

Dimensions

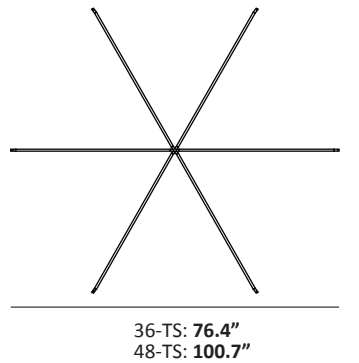

36-TS: 66.5"
48-TS: 87.5"

Remote Transformer

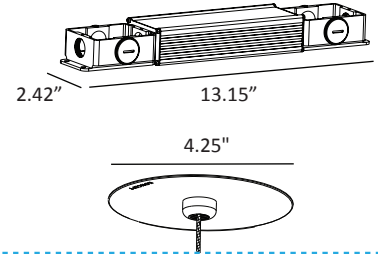

LEED information

Integrative Process

To support high-performance, cost-effective project outcomes through an early analysis of the interrelationships among systems.

Koncept's LED lighting fixtures operate at high efficacy, therefore helping to minimize energy costs. All Koncept lighting fixtures are dimmable so that occupants can choose the appropriate setting to avoid energy overuse.

Interior Lighting

To promote occupants' productivity, comfort and well-being by providing high-quality lighting.

Koncept's entire line of hardwired lighting fixtures are dimmable. Users can adjust the brightness settings to suit their needs. Furthermore, all products utilize high quality LED light sources with CRI over 80 and L90 rated lifespan over 60,000 hours.



On GSA schedule

koncept



Z-Bar pendant *quad-star*

The Z-Bar Pendant quad-star is a striking configuration of eight LED light bars. Available in three standard finishes and two standard sizes, it brings light, modernity and a sense of drama to any interior.

Standard Configurations



quad-star with 36" light bars



quad-star with 48" light bars

Standard Configurations

Lumens: 36-QS: 7200 / 48-QS: 9600
 Energy Consumption: 36-QS: 120 W / 48-QS: 160 W
 Rated Lifespan: >60,000 hours
 Color Rendering Index (CRI) : 90
 Brightness Adjustability: For CNP Option : Compatible with ELV wall dimmers
 For RTM Option : 1 – 10V dimming control only
 Material: Aluminum, plastic
 Cable length: 10'
 Safety Rating: C-UL-US Certified, CE
 Warranty: 5 years; 1 year for hardwire driver
 Voltage: 277V (remote transformer)
 Standard Finishes: Matte black, gold, silver

*Visit koncept.com/dimmers for information on compatible dimmers.
 Remote transformers are only compatible with 1-10V dimmers.

Power placement

The Z-Bar pendant quad-star can only be mounted by multipoint installation.
Remote transformers are sold separately and are only available for multipoint installation.

How to specify

1. Choose an option from each column and enter into the appropriate fields at the bottom.
2. Submit this "SKU" to sales@koncept.com, along with any questions.

ZBP	Light Bar Length (in) (this is length of each light bar, NOT length of fixture.)	Model QS	Light Temperature (K)	Finish	Mount Remote Transformer (RTM)
	16*		2,700*	Silver (SIL)	
	24*		3,000 (SW)	Matte Black (MTB)	
	36		3,500*	Gold (GLD)	
	48		4,000*	Matte White (MWT)*	
			4,500*		
			5,000*		

Order example: ZBP - 48 - QS - SW - SIL - RTM

*Custom
 Remote Transformer is recommended for any configuration requiring more than 40 W energy consumption
 Additional lead time/charges may be applied to non-stocked options

Dimensions

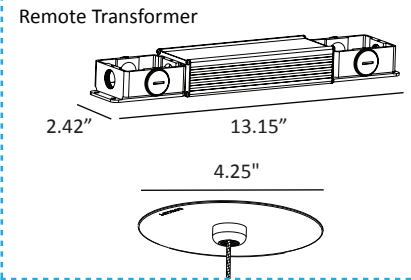
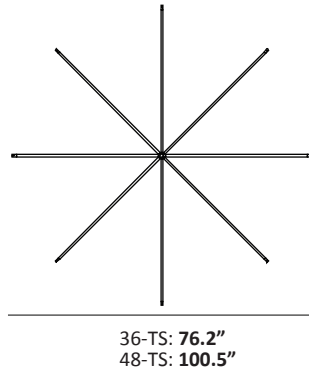

LEED information

Integrative Process

To support high-performance, cost-effective project outcomes through an early analysis of the interrelationships among systems.

Koncept's LED lighting fixtures operate at high efficacy, therefore helping to minimize energy costs. All Koncept lighting fixtures are dimmable so that occupants can choose the appropriate setting to avoid energy overuse.

Interior Lighting

To promote occupants' productivity, comfort and well-being by providing high-quality lighting.

Koncept's entire line of hardwired lighting fixtures are dimmable. Users can adjust the brightness settings to suit their needs. Furthermore, all products utilize high quality LED light sources with CRI over 80 and L90 rated lifespan over 60,000 hours.



On GSA schedule



Z-Bar pendant *triangle*

The triangle is an often-forgotten shape when it comes to lighting design. The angular Z-Bar Pendant triangle enlivens any room with diffused LED light. Available in three standard finishes and two standard sizes, it brings a refreshing hint of modernity to any interior.

Standard Configurations



triangle with 16" light bars



triangle with 24" light bars

Standard Configurations

Lumens:	16-T: 1200 / 24-T: 1800
Energy Consumption:	16-T: 21 W / 24-T: 30 W
Rated Lifespan	>60,000 hours
Color Rendering Index (CRI) :	90
Brightness Adjustability:	For CNP Option : Compatible with ELV wall dimmers For RTM Option : 1 – 10V dimming control only
Material:	Aluminum, plastic
Cable length:	10'
Safety Rating:	C-UL-US Certified, CE
Warranty:	5 years; 1 year for hardwire driver
Voltage:	120 V (Custom 277V option available, ask for details)
Standard Finishes:	Matte black, matte white, silver

Visit koncept.com/dimmers for information on compatible dimmers.
Remote transformers are only compatible with 1-10V dimmers.

Power placement

There are two ways to mount the Z-Bar pendant triangle using the canopy: monopoint installation or multipoint installation.

Remote transformers are sold separately and are only available for multipoint installation.

Monopoint installation

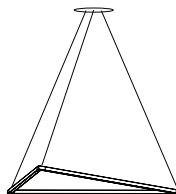

Multipoint installation

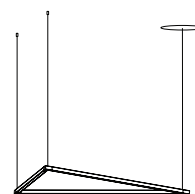

How to specify

1. Choose an option from each column and enter into the appropriate fields at the bottom.
2. Submit this "SKU" to sales@koncept.com, along with any questions.

ZBP	Light Bar Length (in) (this is length of each light bar, NOT length of fixture.)	Model T	Light Temperature (K)	Finish	Mount
	16		2,700*	Silver (SIL)	Canopy (CNP)**
	24		3,000 (SW)	Matte Black (MTB)	Remote Transformer (RTM)**
	36*		3,500*	Matte White (MWT)	
	48*		4,000*	Gold (GLD)*	
			4,500*		
			5,000*		

Order example: **ZBP** - **36** - **T** - **SW** - **SIL** - **CNP**

*Custom

**Remote Transformer is recommended for any configuration requiring more than 40 W energy consumption
Additional lead time/charges may be applied to non-stocked options

Dimensions

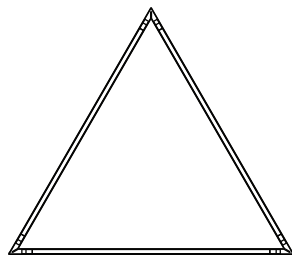

16-T: 18.4"
24-T: 26.39"

16-T: 15.9"
24-T: 22.88"

Canopy

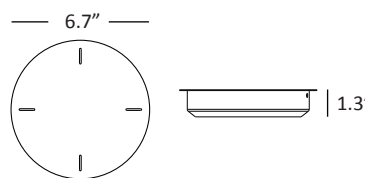

Remote Transformer

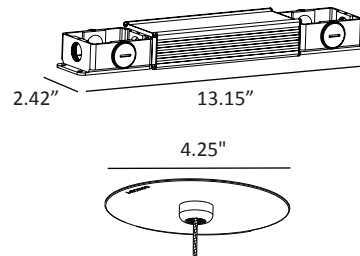

LEED information

Integrative Process

To support high-performance, cost-effective project outcomes through an early analysis of the interrelationships among systems.

Koncept's LED lighting fixtures operate at high efficacy, therefore helping to minimize energy costs. All Koncept lighting fixtures are dimmable so that occupants can choose the appropriate setting to avoid energy overuse.

Interior Lighting

To promote occupants' productivity, comfort and well-being by providing high-quality lighting.

Koncept's entire line of hardwired lighting fixtures are dimmable. Users can adjust the brightness settings to suit their needs. Furthermore, all products utilize high quality LED light sources with CRI over 80 and L90 rated lifespan over 60,000 hours.



On GSA schedule



Acoustic Panels

Compatible with multiple Z-Bar Pendant models, Koncept's line of acoustic panels are an attractive solution to sound absorption. Panels are available in ten different finishes to complement your room's acoustics and aesthetics. They can be mounted flat onto each pendant or upright along the suspending wires, for a three-dimensional look. All acoustic panels have a lead time of 8-10 weeks.

Acoustic Solutions



Acoustic Solutions

Thickness: 3/8"
 Height (vertical panels): 15" (custom orders up to 48")
 Fire rating: ASTM E-84
 Acoustics: NRC 0.75
 Material: Minimum 50% post-consumer recycled polyester staple fiber
 Standard finishes: Black Shadow, Berry Red, Charcoal, Concrete, Leaf Green, Light Marble, Mustard, Twilight Blue, Tangerine, White Sand
 Compatible Z-Bar Pendants: Honeycomb, Square, Triangle, Rectangle*, Trio, Cross, Rise Square*, Rise Rectangle
 Oeko-Tex Standard 100 compliant
 Fully recyclable
 *Vertical acoustic panels not available for this product

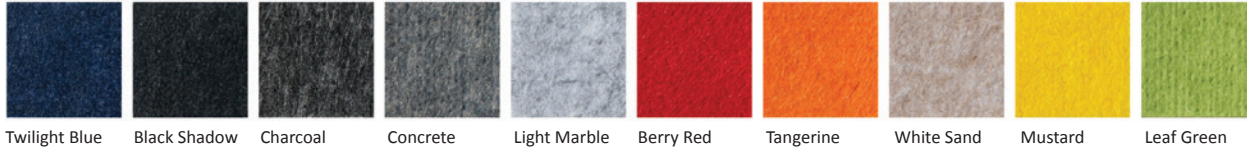

Vertical Acoustic Panels

	Light Bar Length (in)		Finish
P4-ZBP	16	LB	Black Shadow (BLS)
	24		Berry Red (BYR)
	36		Charcoal (CCL)
	48		Concrete (CON)
			Leaf Green (LGN)
			Light Marble (LTM)
			Mustard (MST)
			Twilight Blue (TLB)
			Tangerine (TNG)
			White Sand (WTS)

Order example: P4-ZBP - 24 - LB - TLB

Vertical panel SKU represents a single panel. Orders should reflect 1 panel per light bar, eg. 3 panels for ZBP Triangle, 4 for ZBP Square. Contact sales@koncept.com with questions.

Acoustic Solutions

Horizontal Acoustic Panels

How to specify

1. Choose an option from each column and enter into the appropriate fields at the bottom.
2. Submit this "SKU" to sales@koncept.com, along with any questions.

	Light Bar Length (in)	ZBP model	Finish	
P4-ZBP	16	Honeycomb (H)	Black Shadow (BLS)	Light Marble (LTM)
	24	Square (S)	Berry Red (BYR)	Mustard (MST)
	36*	Triangle (T)	Charcoal (CCL)	Twilight Blue (TLB)
	48**	Rectangle (R)	Concrete (CON)	Tangerine (TNG)
		Rise Square (RS)	Leaf Green (LGN)	White Sand (WTS)

Order example: P4-ZBP - 24 - T - TLB

*size unavailable for Honeycomb and Rise Square
 **size unavailable for Square and Honeycomb

	Light Bar Length (in)	ZBP model	Finish	
P4-ZBP	38	Rise Rectangle (RR)	Black Shadow (BLS)	Light Marble (LTM)
	54		Berry Red (BYR)	Mustard (MST)
			Charcoal (CCL)	Twilight Blue (TLB)
			Concrete (CON)	Tangerine (TNG)
			Leaf Green (LGN)	White Sand (WTS)

Order example: P4-ZBP - 54 - RR - WTS

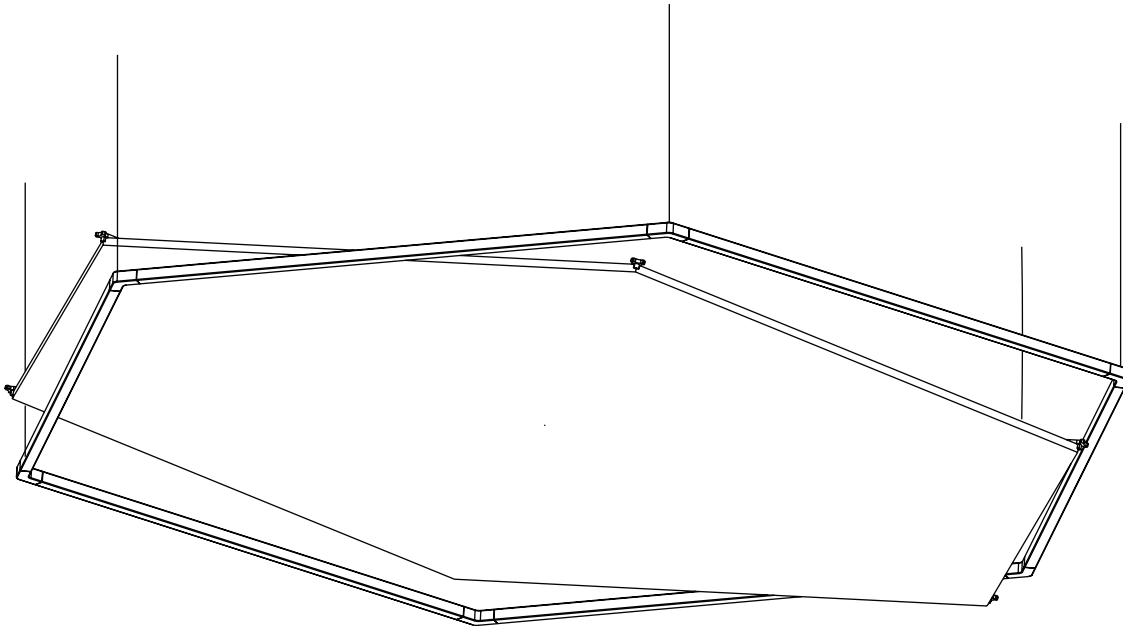

On GSA schedule