

KONCEPT



Floor

Dynamic. Efficient. Flexible.

Designers
Kenneth Ng, Edmund Ng

Splitty floor lamp

Splitty Floor Lamp delivers maximum functionality with a contemporary profile. The shape of the LED head reflects the root of its inspiration: water droplets. The fluidity of water is also referenced in the smooth and fluid motion of its movement. A USB port is located in the lower body for as a charging option for phones, tablets, et cetera.



Splitty Floor Lamp's upper body utilizes the same special joint mechanism found in the Splitty Desk Lamps. This joint allows the upper body to bend forward and back, providing ample flexibility. The LED head can similarly bend forward and back and also rotate 360°. A gentle nudge will rotate the entire lamp around the base.

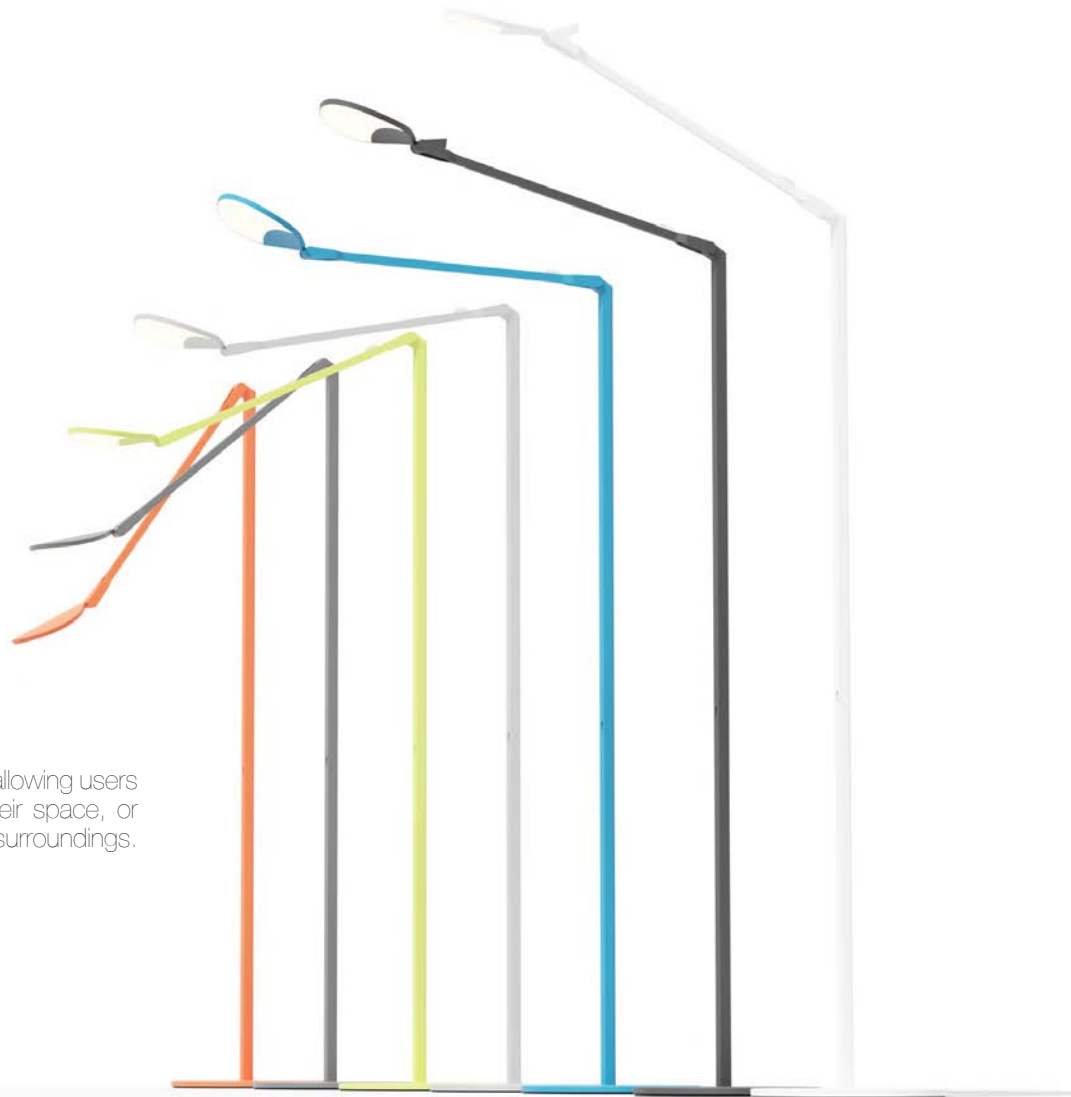

Splitty is available in seven finishes, allowing users to introduce a pop of color into their space, or have the lamp blend into its surroundings.





Splitty Floor Lamp's diffused and dimmable light can be enjoyed for tasks such as reading or simply for ambience. Turn the LED head towards a wall to cast a soft, warm glow.



Lumens: 500
 Footcandles: 117
 Lux: 1259
 Energy Consumption: 5.8 W
 Rated Lifespan: 50,000 hours
 Color Temperature: Warm (3,500 K)
 Color Rendering Index (CRI) : 90
 Brightness Adjustability: Continuous dimming
 Material: Aluminum, plastic
 USB port: Built-in; 1A
 Occupancy Sensor: N/A
 Safety Rating: C-UL-US Certified
 Voltage: 120V
 Standard Finishes: Silver, Matte Black, Matte White, Matte Grey, Matte Pacific Blue, Matte Leaf Green, Matte Orange

SPY - W - _____ - USB - FLR

- SIL = Silver
- MTB = Matte Black
- MGY = Matte Grey
- MPB = Matte Pacific Blue
- MLG = Matte Leaf Green
- MWT = Matte White
- MOR = Matte Orange

Dimensions

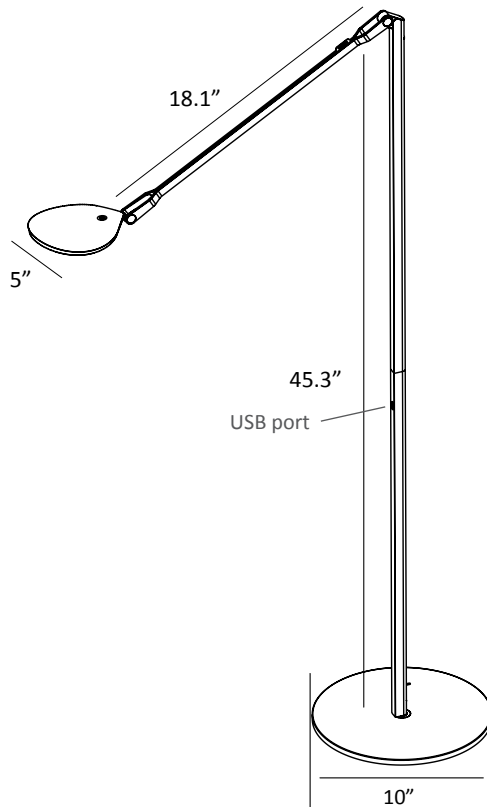

Photometrics: Light source placed 15" away from work surface

LEED Information

Integrative Process

To support high-performance, cost-effective project outcomes through an early analysis of the interrelationships among systems.

Koncept's LED desktop and task lighting provides finer control over lighting levels in occupied spaces. With personal lighting in place, elimination or downsizing of building lighting systems is possible.

Interior Lighting

To promote occupants' productivity, comfort and well-being by providing high-quality lighting.

Koncept's portable task lighting products provide more than three lighting levels that occupants can easily adjust to suit their needs. Furthermore, all Koncept lighting products use high quality LED light sources with CRI over 80 and L70 rated lifespan over 50,000 hours. Desktop and task personal lighting also provide the opportunity to reduce overhead lighting.

